



Alfresco[™]
Open Air Culinary Systems





Welcome

For decades, the founders of Alfresco have been designing and manufacturing commercial kitchen equipment for many of the world's finest restaurants and hotels that rely on the highest quality products.

In the late 90's, Alfresco Open Air Culinary Systems was launched, offering a complete line of restaurant-inspired residential outdoor kitchen appliances; an entirely new level of luxury never before available for the home.

From the beginning, Alfresco has focused on producing high-performance products of the likes that have never occurred in the outdoor cooking industry. This dedication to quality in manufacturing, innovation, value, and customer satisfaction continues to shape the Alfresco brand, and set the standard for what the ultimate outdoor cooking experience should be.

Inspire yourself. Nurture your culinary genius. Alfresco appliances will make any professional chef feel right at home, as well as motivate anyone who wishes to produce masterful creations like a pro. If you can imagine it, you can create it with Alfresco.

Table of Contents

05	INDUSTRY FIRSTS
06	15 WAYS TO COOK
10	LUXURY GRILL DETAILS
19	ALFRESCO LUXURY GRILLS
28	GRILL ACCESSORIES
30	PIZZA OVEN PLUS
36	VERSA POWER™
40	SIDE BURNERS
44	DOORS AND DRAWERS
46	PREP AND PLATING
48	OUTDOOR REFRIGERATION
51	SEALED PANTRIES
52	VERSA SINKS AND BEVERAGES
56	FOOD WARMING
60	DESIGN SERVICES
64	INSTALLATION

Alfresco[™]
Open Air Culinary Systems

**YOUR PASSION
IGNITED™**



CULINARY PERFORMANCE AMPLIFIED

For passionate foodies, cooking equipment becomes an extension of the creative mind. But no matter how gentle your touch, if your grill can't manage the subtle control necessary to make a dish go above and beyond, then the appliance you're using doesn't qualify.

Think of a high-performance sports car; all of the horsepower behind the engine means nothing if you can't control it with precision. The Alfresco Luxury Grill is a fine-tuned machine with proprietary features that will fuel your passion and potential, allowing you to make truly extraordinary meals.



First infrared burner combined with stainless steel burners (Sear Zone™ was born).

First cantilever canopy with hidden coil spring assist.

First integrated rotisserie motor.

First full-length, extra-wide, deep under-mount smoker with a dedicated burner.

First and only air-cooled front breathing control panel.

First easy-to-remove LED light panel.

First manufacturer of the largest professional grill at 56".

First and only "Fire and Ice" grill on a refrigerated cart.

First to produce a Versa Power™ burner.

First to produce a stainless steel convertible refrigerator that accommodates a full half keg.

First and only built-in under-grill/under-counter refrigerator.

First grill company to produce their own refrigeration designed on a commercial platform.

First to produce, and still offers the largest selection of "plug-and-play" drop-in grill accessories.

First to produce a full sealed pantry in both under-grill (low) and under-counter (tall) models.

First to incorporate sink design and sink accessories into outdoor kitchens.

First to produce a trash chute.

First to produce the widest selection of built-in island accessories.

First to produce an outdoor pizza oven for both countertop and built-in applications.

First to offer FREE design services.

First outdoor plating station.

First to introduce the concept of outdoor kitchen zones.

15

WAYS TO COOK

Only the Alfresco Outdoor Kitchen offers this many ways to cook!



Searing



Rotisserie Cooking



Grilling



Steaming



Boiling



Frying



Griddling



Smoking



Roasting



Baking



Braising



Wok Cooking



Blanching



Teppanyaki



Cold Smoke Roasting





ALFRESCO LUXURY GRILL DETAILS

SIGNATURE TASTE™ INTEGRATED SMOKING SYSTEM

MAKE A TASTEFUL IMPRESSION.

Adding unique, real-smoke-flavors to your outdoor cooking is surprisingly simple. Every Alfresco grill comes equipped with our state-of-the-art Signature Taste™ integrated smoking system, allowing for unparalleled originality. From "smoketissing" to cold-smoke roasting, no other grill in the world offers more control, power, and versatility. With a dedicated stainless steel burner, our exclusive Signature Taste™ smoking system opens a whole new world of flavors for the aspiring outdoor chef. The drawer holds large chunks of wood and herbs, and linear diffusing vents naturally eject smoke at 200° to the food zone (right).



ALFRESCO'S EXCLUSIVE ACCUFIRE™ HEAT SYSTEM

At Alfresco, we understand that precision-directed power is essential for any true high-performance culinary appliance. You can be confident in the control and accuracy built into our 18SR stainless steel Accufire™ grilling engine. This commercially-inspired fire delivery method creates some of the highest cooking temperatures in the industry, and serves as the suspension system for "the ultimate grilled food" coming from your customized outdoor kitchen. With dual rows of corrosion-resistant, clean-combusting, double-lanced ports and a lifetime warranty, this grill is built to last a lifetime.



OPTIONAL SEAR ZONE™ FOR INFRARED COOKING

Savory meats rely on quick, intense heat. The Alfresco Sear Zone™ Infrared Burner amplifies flavors for virtually any entrée you plan to grill, locking in the juices of a filet mignon, chicken breast, or even a seafood shrimp skewer. This high-tech Sear Zone™ burner reaches 1500°F in four minutes, and cooks 50% faster with virtually no flare-ups. The special "V-shaped" flavorizer cooking grate also captures the natural juices, fats, and flavors, then caramelizes them to the food for delectable, mouthwatering flavor. This means savory, melt-in-your-mouth proteins, all at your control.





All of our products are designed by commercial appliance experts and built by grill industry veterans. Made from all commercial-grade 304, 18-8 stainless steel with all heli-arc hand-welded seams and no mechanical fasteners, it's no wonder Alfresco is recognized as the best-of-the-best (*right*).

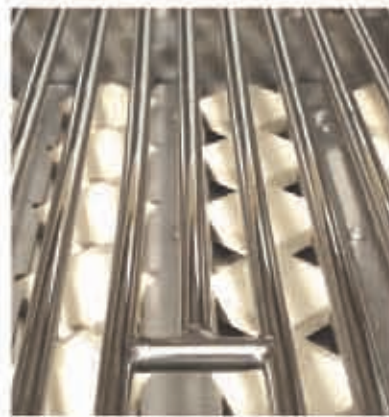

ELECTRO-POLISHED STAINLESS STEEL COOKING GRATES

Sitting over the briquette and "U" burner sections, these ultra-premium grates are made from heavy-duty 3/8-inch round stainless steel rod, and have a special nonstick electro-polished finish.



EXCLUSIVE SAFETOUCH™ AIR-COOLED CONTROL PANEL

Our exclusive SafeTouch™ design creates an insulating barrier of ambient air flowing between the front panel and the grill firebox. This results in all of the control components staying safe to the touch. We like to say we are "Grandchild Safe!"



ERGONOMIC CONTROLS

Easy-to-reach, stainless steel push-button ignition, lighting, and rotisserie controls are ergonomically integrated into the front control panel.



PRECISION-POINT™ CONTROL PANEL LIGHTING

Precise LED front panel lighting projects rich amber beams of light exactly where you need them (*left*).

EXCLUSIVE DURASLEEVE™ HEAT-PROTECTED WIRING

Alfresco's exclusive wire protection system encapsulates the full length of every wire and connection point with a 600° heat-resistant silicone sleeving, ensuring years of unmatched weather-resistant performance.



NICKEL-PLATED KNOBS AND BEZELS

Like the steering wheel of a high-performance race car, Alfresco grill knobs are designed for precise maneuvers. Placed at exacting positions, these corrosion-resistant cooking controls have been designed to specifically address ergonomics and accuracy for the outdoor culinary chef.



REFRACTIVE CERAMIC 5-WAY HEAT DISTRIBUTING BRIQUETTES

Eliminates hot and cold spots, making the effective grilling area 100% of the grilling surface. High-density composite material in a flat top pyramid-shape, with a heat-holding cavity underneath, delivers intense heat to the cooking surface. Radiant tray locks briquettes in place.



HALOGEN RADIANT LIGHTING

Designed to focus on the subject, Alfresco's Integrated high-intensity halogen lights angle slightly toward the center of the cooking surface, creating bright, even illumination. The light lenses are easily removable without the use of tools.





INSET ROTISSERIE BURNER

All Alfresco grills come with a flush-mounted rear ceramic infrared rotisserie burner. In conjunction with our integrated Mega-Drive™ motor system, rotisserie cooking perfection has never been easier. From whole chickens and ribeye roasts, to cornish game hens and ribs, the Alfresco rotisserie cooking system supports and nurtures the delicate touch required to create a perfectly tender and caramelized entrée. *(left).*

EXCLUSIVE HIDDEN AND INTEGRATED MEGA-DRIVE™ ROTISSERIE SYSTEM

This unique, chain-driven, whisper-quiet food rotation system is perfectly smooth and consistent, and is designed for ultra-roasting from the smallest to the largest of entrées. We build the Mega-Drive™ directly into the grill assembly making it weather-resistant, and allowing for hassle-free, delicious roasted foods.



EXCLUSIVE EZ-LIFT™ HOOD-ASSIST SYSTEM

Save your strength. Alfresco's integrated and commercially-inspired spiral torsion hood-assist system offers ultra-smooth, single-finger hood lifting and closing while you cook. Made of non-corrosive stainless steel, the EZ-Lift™ hood design is built for many years of reliable performance.

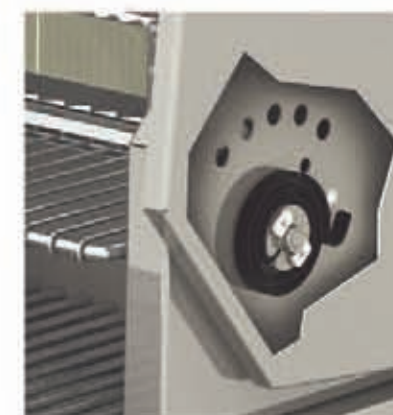

ADJUSTABLE FOOD WARMING AND GRILLING RACK

This versatile, three-position adjustable warming rack is ideal for above-the-grates cooking, food holding, and warming,





56" LUXURY ALL GRILL

It doesn't get bigger. It doesn't get more powerful. For those who want more, with incredible performance and a massive 998 sq. in. grilling area, the ALXE-56BFG All Grill is your new favorite outdoor cooking companion.

- Three 18-SR stainless steel high-performance Accufire™ main burners
- Sear Zone™ high-tech ceramic infrared burner
- Integrated Mega-Drive™ rotisserie system with dual infrared burners designed for premium performance
- Signature Taste™ integrated smoking system with dedicated burner and drawer for wood chunks
- 998 sq. in. actual grilling area
- 3-position warming rack stores up and out of the way when rotissing
- Dual integrated high-intensity halogen lights
- User-friendly push-button ignition with sealed 110V AC power source
- Optional standard cart, or refrigerated cart
- Available in LP or Natural Gas



Built-in Model



Standard Cart



Refrigerated Cart

AVAILABLE MODELS

Built-in Models:

ALXE-56BFG – 56" Built-in Grill, 3 Burner, Rotis, Smoker, SearZone™

Cart Models:

ALXE-56BFGC – 56" Cart Grill, 3 Burner, Rotis, Smoker, SearZone™, Double Doors w/ Drawers

ALXE-56BFGR – 56" Refrigerated Cart Grill, Burner, Rotis, Smoker, SearZone™, 1 Door and 2 Drawers are Refrigerated, and a Single Storage Door



56" LUXURY DELUXE GRILL

With an integrated dual side burner, the ALXE-56 Deluxe Grill offers a robust 770 sq. in. of grilling space, with additional room for boiling, heating, and other creative culinary needs.

- Three 18-SR stainless steel high-performance Accufire™ main burners
- Integrated Mega-Drive™ rotisserie system with infrared burner designed for premium performance
- Signature Taste™ integrated smoking system with dedicated burner and drawer for wood chunks
- 770 sq. in. actual grilling area
- 3-position warming rack stores up and out of the way when rotissing
- Dual integrated high-performance side burner with recessed sealed top and stainless steel cover
- Dual integrated high-intensity halogen lights
- User-friendly push-button ignition with sealed 110V AC power source
- Optional standard cart, or refrigerated cart
- Optional infrared Sear Zone™
- Available in LP or Natural Gas



Built-in Model



Standard Cart



Refrigerated Cart

AVAILABLE MODELS

Built-in Models:

ALXE-56 – 56" Built-in Grill, 3 Burner, Rotis, Smoker

ALXE-56SZ – 56" Built-in Grill, 2 Burner, Rotis, Smoker, SearZone™

Cart Models:

ALXE-56C – 56" Cart Grill, 3 Burner, Rotis, Smoker, Double Doors w/ Drawers

ALXE-56SZC – 56" Cart Grill, 2 Burner, Rotis, Smoker, SearZone™, Double Doors w/ Drawers

ALXE-56R – 56" Refrigerated Cart Grill, 3 Burner, Rotis, Smoker, 1 Door and 2 Drawers are Refrigerated

ALXE-56SZR – 56" Refrigerated Cart Grill, 2 Burner, Rotis, Smoker, SearZone™, 1 Door and 2 Drawers are Refrigerated

42" LUXURY GRILL

The go-to grill for any outdoor kitchen enthusiast, you can count on the ALXE-42 Luxury Grill for size, performance, and power for any and all of your open-air culinary aspirations.

- Three 18-SR stainless steel high-performance Accufire™ main burners
- Integrated Mega-Drive™ rotisserie system with infrared burner designed for premium performance
- Signature Taste™ integrated smoking system with dedicated burner and drawer for wood chunks
- 770 sq. in. actual grilling area
- 3-position warming rack stores up and out of the way when rotissing
- Dual integrated high-intensity halogen work lights
- User-friendly push-button ignition with sealed 110V AC power source
- Optional standard cart, deluxe cart, or refrigerated cart
- Optional infrared Sear Zone™
- Available in LP or Natural Gas



Deluxe Cart



Built-in Model



Standard Cart



Refrigerated Cart

AVAILABLE MODELS

Built-in Models:

ALXE-42 – 42" Built-in Grill, 3 Burner, Rotis, Smoker

ALXE-42SZ – 42" Built-in Grill, 2 Burner, Rotis, Smoker, SearZone™

Cart Models:

ALXE-42C – 42" Cart Grill, 3 Burner, Rotis, Smoker, Double Door Cart

ALXE-42CD – 42" Cart Grill, 3 Burner, Rotis, Smoker, Deluxe Cart with 1 Door and 2 Drawers

ALXE-42SZC – 42" Cart Grill, 2 Burner, Rotis, Smoker, SearZone™, Double Door Cart

ALXE-42SZCD – 42" Cart Grill, 2 Burner, Rotis, Smoker, SearZone™, Deluxe Cart with 1 Door and 2 Drawers

ALXE-42R – 42" Refrigerated Cart Grill, 3 Burner, Rotis, Smoker, 1 Door and 2 Drawers are Refrigerated

ALXE-42SZR – 42" Refrigerated Cart Grill, 2 Burner, Rotis, Smoker, SearZone™, 1 Door and 2 Drawers are Refrigerated

36" LUXURY GRILL

The ALXE-36 Luxury Grill is a midsize powerhouse, offering 660 sq. in. of grilling area for those with a touch less space but all the same ambition. The perfect centerpiece for your ultimate open-air kitchen!

- Three 18-SR stainless steel high-performance Accufire™ main burners
- Integrated Mega-Drive™ rotisserie system with infrared burner designed for premium performance
- Signature Taste™ integrated smoking system with dedicated burner and drawer for wood chunks
- 660 sq. in. actual grilling area
- 3-position warming rack stores up and out of the way when rotissing
- Dual integrated high-intensity halogen lights
- User-friendly push-button ignition with sealed 110V AC power source
- Optional infrared Sear Zone™
- Optional standard cart
- Available in LP or Natural Gas



Built-in Model



Standard Cart



Grill Accessory Grate

For use with Alfresco drop-in grill accessories, this insert set creates the maximum grilling surface on your 36" grill while using grill accessories. XE-36AG

AVAILABLE MODELS

Built-in Models:

ALXE-36 – 36" Built-in Grill, 3 Burner, Rotis, Smoker

ALXE-36SZ – 36" Built-in Grill, 2 Burner, Rotis, Smoker, SearZone™

Cart Models:

ALXE-36C – 36" Cart Grill, 3 Burner, Rotis, Smoker, Double Door Cart

ALXE-36SZC – 36" Cart Grill, 2 Burner, Rotis, Smoker, SearZone™, Double Door Cart



30" LUXURY GRILL

With compact, no-nonsense cooking space, the ALXE-30 Luxury Grill proves that high performance and power can come in small packages.

- Two 18-SR stainless steel high-performance Accufire™ main burners
- Integrated Mega-Drive™ rotisserie system with infrared burner designed for premium performance
- Signature Taste™ integrated smoking system with burner and drawer for wood chunks
- 542 sq. in. actual grilling area
- 3-position warming rack stores up and out of the way when rotissing
- Dual integrated high-intensity halogen lights
- User-friendly push-button ignition with sealed 110V AC power source
- Optional infrared Sear Zone™
- Optional standard cart
- Available in LP or Natural Gas



Built-in Model



Standard Cart

AVAILABLE MODELS

Built-in Models:

ALXE-30 – 30" Built-in Grill, 2 Burner, Rotis

ALXE-30SZ – 30" Built-in Grill, 1 Burner, Rotis, SearZone™

Cart Models:

ALXE-30C – 30" Cart Grill, 2 Burner, Rotis, Smoker, Double Door Cart

ALXE-30SZC – 30" Cart Grill, 1 Burner, Rotis, Smoker, SearZone™, Double Door Cart



STEAMER / FRYER / PASTA COOKER



Drop into any Alfresco grill to blanch, steam, fry, or broil. From deep-fried chicken tenders and onion rings, to mussels, clams, and even lobster, no other outdoor grill has more cooking versatility! AG-SF



SOLID FUEL INSERT

Transform your Alfresco grill into a wood-source cooking system. Simply drop the specially-designed insert into the grill, and fill up with your favorite wood, lump charcoal, or other solid fuel for real wood-cooking flavor. SFI-POD



COMMERCIAL GRIDDLE



This 3/16" solid stainless steel griddle plate with integrated sides and backsplash, is a solid drop-in accessory that is great for Teppanyaki, fajitas, breakfast, or juicy burgers. AGSQ-G



INDIRECT ROASTING POD



Turn your grill into an amazing roasting oven with Alfresco's indirect roasting pod. Holds drip pan for self-basting, bringing out true slow-roast flavor. Use adjacent burner(s) to create convection heat, or smoke-and-roast using the Signature Taste™ smoke and herb infusion system. AIC-POD



CART-MOUNTED DUAL SIDE BURNER

Features two high-performance burners, and easily attaches to any Alfresco cart model grill for added cooking versatility. AXESB-2C (Cart)



WIND GUARDS

For windy, exposed environments that may affect cooking performance and consistency, our all stainless steel wind guard integrates perfectly with any or our Alfresco grills. AWS-56 (Built-in), AWS-56C (Cart), AWS-42 (Built-in), AWS-42C (Cart), AWS-36 (Built-in), AWS-36C (Cart), AWS-30 (Built-in), AWS-30C (Cart)



INSULATED JACKET

If your enclosure is to be built of combustible materials, then an insulated jacket is required for safe installation of your grill. AIJ-56, AIJ-42, AIJ-36, AIJ-30



GRILL COVER

Protect your investment from the elements when you're not cooking with Alfresco's premium high-density canvas grill cover with embroidered logo. AGV-56BFG (Built-in), AGV-56BFGC (Cart), AGV-56 (Built-in), AGV-56C (Cart), AGV-42 (Built-in), AGV-42C (Cart), AGV-36 (Built-in), AGV-36C (Cart), AGV-30 (Built-in), AGV-30C (Cart)

GRILL ACCESSORIES

Variety is the spice of life. With Alfresco's extensive line of grill accessories, you have countless opportunities to express your culinary creativity. From searing, steaming, and frying, to baking, Teppanyaki, and rotisserie, there's something for every taste and any occasion. *(Grill shown with optional wind guard)*



PIZZA OVEN PLUS

Alfresco Pizza Oven Plus ovens are built to be the most versatile and highest-performing gas-fired ovens in the world. Our material, design, and manufacturing process revolves around creating a uniquely powerful oven that preheats in 15 minutes and can reach up to 1,000° F, allowing you to bake, roast, iron-skillet sear, and of course, cook perfect three-minute Neapolitan pizzas.





HIGH-TEMPERATURE COOKING

Truly great pizza requires temperatures that conventional ovens can't reach. The Pizza Oven Plus reaches up to 1,000° F to give you the ideal balance of thin, crisp base, and perfectly charred artisan crust.



AMAZING CULINARY CREATIONS

With a preheat time of only 15 minutes, the Pizza Oven Plus is great for cooking pizza, baking, broiling, roasting, and just about anything else you can do in a regular oven, but faster and with better results!



PIZZA AND SO MUCH MORE!

Cooking 3-minute Neapolitan pizzas directly on the hearth, Prime New York steaks pan-seared in an iron skillet, herb and spice rubbed pork chops in a ceramic baking dish; all can be done in Alfresco's Pizza Oven Plus!





PIZZA OVEN PLUS

- Fireplace-like gas log absorbs and radically accelerates preheat time as it distributes heat up to the ceramic ceiling slab for intense top-down heat
- 3/4" thick high-quality ceramic slab hearth and ceiling for even, intense, radiating heat
- All 304 18-8 heli-arc welded stainless steel
- Full 8.5" opening with stainless steel-framed glass doors
- Countertop rear exhaust
- High-performance tube-log burner
- High-tech, high-heat ceramic infrared hearth burner
- Removable hinges/doors
- Double-walled removable top
- 456 sq. in. of cooking space
- Halogen oven light
- Alfresco's exclusive natural air-cooling plenum keeps control panel cool to the touch
- Available in LP or Natural Gas

AVAILABLE MODELS

- AXE-PZA - Countertop Model
- AXE-PZA-BI - Built-in Model



Countertop



Built-in



PIZZA OVEN CART

Our sturdy pizza oven cart creates mobility for your pizza oven when counter space is at a premium. AXE-PZA-CART



PIZZA PREP CART

The Pizza Prep Cart creates the ultimate in convenience. Includes a plate shelf, cutting board, pan rail, and additional storage. AXE-PZA-PPC



PIZZA PREP AND GARNISH CENTER

Pizza prep and garnish rail with food pans. APS-30PPC (see page 47 for details)



All Alfresco Pizza Ovens come standard with a smoker tray and positionable thermostat.



VERSA POWER™

The Versa Power™ cooking system offers an unmatched heating range from 400 to 65,000 BTUs of power for total heat control. The unique, specially designed super heavy-duty spider grate can handle from the smallest of saucepans up to 100-quart stock pots. With numerous options to expand its versatility, it is the perfect complementary appliance to complete your outdoor kitchen.



24" VERSA POWER™ COOKER

- Power and versatility at your fingertips with numerous options
- Unique, individually-controlled double burner system
- Brass center burner adjusts from 400 to 20,000 BTUs
- Stainless steel outer tube burner adjusts from 5,000 to 45,000 BTUs
- 5/16" diameter stainless steel spider grate with removable trivet
- The perfect complementary appliance to complete your outdoor kitchen
- Ideal for use as European French Top
- Available in LP or Natural Gas
- Available Model: AXEVP



VERSA POWER™ CART
AXEVP-C



COMMERCIAL WOK
Commercial round bottom wok. 21.5" dia. AXEVP-WOK



TEPPANYAKI GRIDDLE
Breakfast griddling, comal tortilla cooking, and more. AXEVP-TG



COUNTER CART
All stainless with storage. AXEVP-COUNTER



TANK HOUSING
Tank attachment for AXEVP-COUNTER. AXEVP-LP TANK



POT FILLER
Install into island next to Versa Power™. Adjustable 0" to 14" with double joint spout. AXEVP-T10



POT FAUCET
Install into a plumbed wall directly behind the Versa Power™ for convenient access. POT FAUCET



Simmer delicate sauces at a low 400 BTU



Center burner adjusts from 400 to 20,000 BTU



Outer burner adjusts from 5,000 to 45,000 BTU



Both together yield an unprecedented 65,000 BTU



The Versa Power™ handles the smallest of saucepans, allowing for unrivaled efficiency and economy. From white wine sauces and Hollandaise, to cream and mustard sauces, you have the control to make the perfect condiment to your perfect open-air meal.



Remove the center ring grate from the Versa Power™ and drop in a true commercial round bottom wok. 21.5" diameter.



The unsurpassed capacity of the Versa Power™ accommodates stock pots up to 100 quarts. Add to this the optional cart, and you have the perfect cooker for tailgating.



SIDE BURNERS

An Alfresco side burner is the perfect complement sitting next to your grill for boiling, heating, and simmering anything you need to put into a pot. Built from all commercial stainless steel with heli-arc welded seams, the side burner features two high-performance burners with electronic ignition. The recessed top and stainless steel cover offers protection from wind and elements. The Sear Zone™ side burner is our ceramic infrared searing system in a convenient, self-contained unit.



SEAR ZONE™ SIDE BURNER

- Sear Zone™ burner – reaches 1500° F in four minutes and cooks 50% faster with virtually no flare-ups
- Restaurant power and control
- 110V electronic ignition
- Precision knob lighting
- Recessed top and stainless steel cover for protection from wind and elements
- Available as a built-in unit, or mounts to cart model grills in place of side tray
- Available in LP or Natural Gas

AVAILABLE MODELS

AXESZ – Sear Zone™ Built-in Side Burner



SIDE BURNER

- Restaurant power and control
- Dual side burner – all commercial stainless steel with heli-arc welded seams
- Two high-performance burners with 110V electronic ignition
- Precision knob lighting
- Recessed top and stainless steel cover for protection from wind and elements
- Available as a built-in unit, or mounts to cart model grills in place of side tray
- Available in LP or Natural Gas

ACCESSORIES

Commercial Griddle

3/16" solid stainless plate with side and back splash. Great for Teppanyaki, fajitas, breakfast, or juicy burgers. AGSB-G



Commercial Wok and Wok Ring

For use on the side burner or on the grill.

AG-WOK – Professional Wok
AG-WR – Wok Ring



AVAILABLE MODELS

AXESB-2 – Built-in 2-Burner Unit

AXESB-2C – 2-Burner Unit for Cart Mount



COMPLETE YOUR KITCHEN

From doors, drawers, and sealed pantries, to sinks, beverage service, and refrigeration, Alfresco offers the most unsurpassed assortment of integrated products to help you complete your ultimate outdoor kitchen.

DOORS AND DRAWERS

Functional and organized storage is a valuable convenience of any well-designed kitchen. Alfresco offers the most complete selection of matching doors, drawers, and creative combinations to help you design your perfectly-planned outdoor kitchen.



17" SINGLE ACCESS DOOR
Left Door: AXE-17L
Right Door: AXE-17R



23" SINGLE ACCESS DOOR
Left Door: AXE-23L
Right Door: AXE-23R



DOUBLE ACCESS DOOR
30" Wide Doors: AXE-30
36" Wide Doors: AXE-36
42" Wide Doors: AXE-42



STORAGE DRAWERS
Two Drawer Unit:
AXE-2DR-SC



STORAGE DRAWERS
Three Drawers:
AXE-3DR-SC



30" STORAGE DRAWER
Oversized for Large Pan:
AXE-30DR-SC



32" COMBO DOOR AND DRAWERS
Door on Left: AXE-DDC-L-SC
Door on Right: AXE-DDC-R-SC



DOOR/DRAWER COMBO
Handle on Left: AXE-DDR-L-SC
Handle on Right: AXE-DDR-R-SC



PAPER TOWEL HOLDER
For Standard Paper Towel Rolls: AXE-TH



DOOR/PAPER TOWEL HOLDER
Handle on Left: AXE-DTH-L
Handle on Right: AXE-DTH-R



THREE DRAWER/PAPER TOWEL HOLDER
AXE-3DRTH-SC



TRASH CENTER
Single Bin: AXE-TC-SC
Double Bin: AXE-TC2D-SC
Includes durable plastic receptacle(s)



DOOR BIN
17" Door: XEDS-1
23" Door: XEDS-2
30" Double Doors: XEDS-3
(Ask your dealer for sizing details)



ACCESS DOOR ENCLOSURES
AXE-17E
AXE-23E
AXE-30E
AXE-36E
AXE-42E
(Sold Separately)



Drawers pull out on soft-close, German-engineered, smooth-gliding, heavy-duty, full-extension slides.



Optional interior system for doors features an adjustable shelf, helping to organize and contain what goes under and into your island kitchen.



Sturdy dual-wall doors feature multiple mounting options and an adjustable accessory door bin. (door bin sold separately)

PREP AND PLATING

Presentation is everything, and to do it right with meals, you need proper space and organization. Alfresco's restaurant-inspired prep and plating stations encourage function and flow as you prepare your culinary masterpieces.



PREP AND WASTE CHUTE

Poly cutting board slides up to reveal a convenient trash chute.

AVAILABLE MODEL

APWC - Prep & Waste Chute

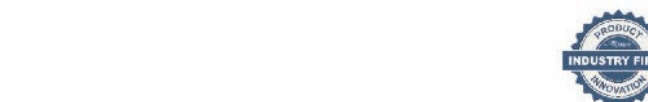

PLATING AND GARNISH CENTER

Restaurant-inspired plating station with food pans, carving board, and plate storage below. Create food presentations like a professional.

- Plate shelf for storing plates, pizza pans, spices, and other necessities
- Convenient removable plastic cutting board
- Ice-cooled pan rail with NSF food pans for pizza toppings and other condiments
- Also ideal as a raw bar, martini, and wine rail
- The ultimate in convenience

AVAILABLE MODELS

APS-30P - Plate & Garnish Rail with Food Pans
 APS-30PPC - Pizza Prep and Garnish Rail with Food Pans



PREP AND HAND SINK

All stainless steel design with hot and cold faucet, removable cutting board, and C-fold towel dispenser.

AVAILABLE MODEL

ASK-T - Prep Plus Hand Wash Sink



7.25 CU.FT. ONE DOOR REFRIGERATOR

The Alfresco one door refrigerator is designed to give you optimal space, consistent temperature, and easily converts into a Keggerator.

- Two removable/adjustable stainless steel shelves
- Field-reversible door
- Easily converts to Keggerator
- Digital control with lighted display
- Commercial fan-driven fin evaporator cooling creates a constant horizontal vortex of air

KEGGERATOR CONVERSION KIT

Alfresco-built keg dispensing tower inserts into the rear of the refrigerator, leaving the top center free of obstruction. Beer dispensing kit includes a stainless steel tower with faucet, a CO₂ tank, beer lines with quick disconnect, pressure gauges, and a drip tray with an anti-splash grate.



AVAILABLE MODELS

- URS-1XE – 7.25 Cu. Ft. Built-in/Freestanding One-door Refrigerator
- AKK – Optional Keggerator Kit for URS-1XE
- ACK – Caster Kit (*not shown*)



7.25 CU. FT. UNDER-GRILL REFRIGERATOR

Restaurant-inspired design offers great ergonomics and versatility. Door section features an adjustable stainless steel wire shelf. Two-drawer section is designed for marinating, and includes removable NSF food pans.

- All stainless steel construction, inside and out
- 1,000 BTU all-weather refrigeration system for deep cooling
- Certified to NSF standards (National Sanitation Foundation)
- Temperatures uniquely adjustable from 27° to 56°
- Commercial fan-driven fin evaporator cooling inside
- Fully front-breathing
- Commercial polyurethane shot-in-place foam insulation
- Flash Recovery System quickly cools internal temperature
- User-friendly digital control with lighted display
- Door-activated internal lighting

AVAILABLE MODELS

ARXE-42 – 7.25 CU.FT Built-in Under-grill Refrigerator
(Also available on select cart model grills)

OUTDOOR REFRIGERATION

Keep it chilled where you need it with Alfresco's commercially-inspired refrigeration systems. From self-contained under-grill units and single-door refrigerators with optional Keggerator conversion kits, to our exclusive Versa Chill™ system, you won't find a cooler, more efficient set up anywhere.



Alfresco's refrigeration can maintain extremely cold internal temperatures in very hot outside temperatures.
(Results may vary due to conditions)

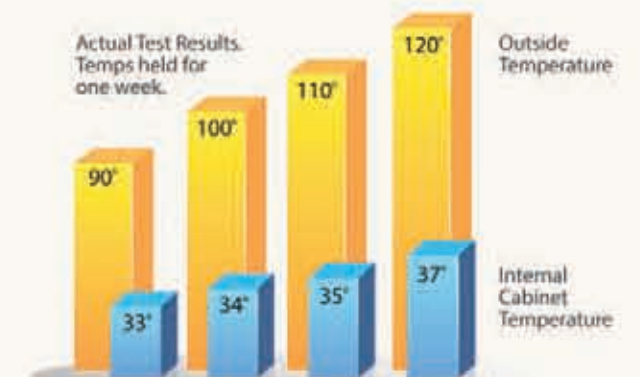

**VERSA CHILL
COUTERTOP REFRIGERATION**



Commercial top-access cooler features state-of-the-art frost wall technology, creating an Arctic blanket of frigid cold air.

- 1,200 BTU all-weather refrigeration system
- Insulated tilt-up and removable stainless steel cover
- Commercial polyurethane shot-in-lace foam insulation
- Three removable NSF food pans
- Slideable intermediate stainless steel wire shelf
- 1" brass drain for easy cleanup
- 101 lb. ice capacity

AVAILABLE MODELS

ARDI – Versa Chill Built-in Model

ARDIC – Versa Chill Cart Model (*not shown*)



SEALED DRY PANTRIES

Store dry goods, cookware, tools, and more in a complementary sealed environment, safe from weather and pests. With five size options to choose from, sealed pantries feature drawers and adjustable shelves. Commercial-style insulated foam gasket on the cabinet face makes for a tight seal, and a new integral rain gutter diverts water around and away from the cabinet.



**ADD A BUILT-IN TO YOUR ISLAND
FOR SUPER CONVENIENT COLD STORAGE**

1. Cold pans for perishable condiments
2. Thermostat-controlled temperature from the teens to 56° F
3. Half-width mid-depth shelf for lower level access
4. Exclusive commercial frost wall technology
5. Frost wall creates an Arctic blanket of frigid cold air

Use as a bottle cooler, mug froster, martini freezer, fresh fruit smoothie and juice center, deli-prep center, burger topping/condiment bar, salsa bar, bottle/ice bath, wine cooler, keg chilling, and dessert bar.



Libation, Smoothie Juice Bar



Ice/Bottle Bath



All-Provision Glass Chiller



Keg Chilling



AXEDSP-30L



AXEDSP-42H

SEALED DRY STORAGE PANTRY



- Keep contents safe from weather and pests
- Insulated foam gaskets on cabinet make for a tight seal
- Five size options to choose from
- Pull-out drawers and adjustable shelves
- Integral rain gutter diverts water away from cabinet

AVAILABLE MODELS

30" Pantries:

AXEDSP-30L – Low Profile Model

AXEDSP-30H – High Profile Model

36" Pantries:

AXEDSP-36L – Low Profile Model

42" Pantries:

AXEDSP-42L – Low Profile Model

AXEDSP-42H – High Profile Model



VERSA SINKS AND BEVERAGE CENTERS

The Versa Sink product line is simply the most versatile and modular outdoor sink and beverage system available anywhere. Our 30" model allows for an assortment of above-sink shelf configurations, including under-shelf lighting and pot rack. From ice pan inserts and bottle wells, to speed rails and towel holders, the Versa Sink can be tailored to accommodate the needs of any outdoor entertaining enthusiast.

14" VERSA SINK AND BEVERAGE CENTER

- Sink basin size: 11" W x 21" D x 8 1/4" H
- 3" basket drain with stopper accommodates disposer
- Full ice capacity: 32 lbs.
- 1" foam insulation on all sides and bottom
- Sliding stainless steel cover
- Separate stainless steel ice pan for sink and ice combo use
- Hang-on front bottle speed rail (3) bottle capacity

AVAILABLE MODELS

AGBC-14 – Bartender and Sink System



24" VERSA SINK AND BEVERAGE CENTER

- Sink basin size: 19" W x 21" D x 8 1/4" H
- 3" basket drain with stopper accommodates disposer
- Full ice capacity: 60 lbs.
- 1" foam insulation on all sides and bottom
- Sliding stainless steel cover
- Hang-on front bottle speed rail (3) bottle capacity
- Bottle opener and towel holder (includes cap catcher)

AVAILABLE MODELS

AGBC-24 – Bartender & Sink System

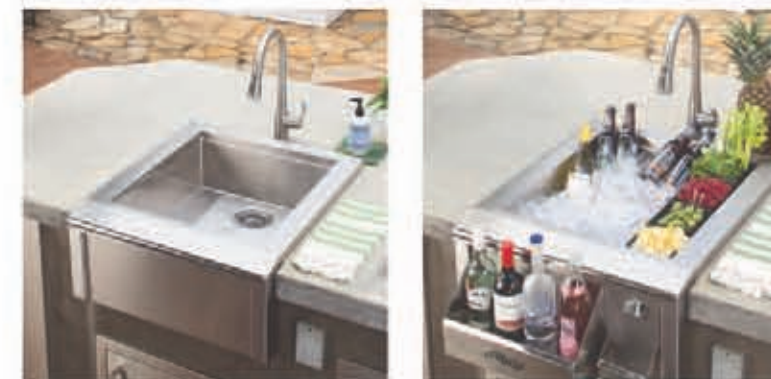

30" VERSA SINK

- Sink basin size: 27" W x 21" D x 8 1/4" H
- 3" basket drain with stopper accommodates disposer
- Full ice capacity: 75 lbs.
- 1" foam insulation on all sides and bottom
- Wood cutting board

AVAILABLE MODELS

AGBC-30 – Versa Sink
(faucet shown is not included)

ACCESSORIES FOR 30" VERSA SINK

Customize your 30" beverage service center with Alfresco's professional-quality collection of accessories.



30" VERSA SINK PACKAGE

- Sink package includes:
 1. Towel holder
 2. Speed rail
 3. Colander

AVAILABLE MODEL
SINK PKG



30" VERSA SINK BAR PACKAGE

- Bar package includes:
 1. Speed rail
 2. Bottle Well
 3. Ice Pan
 4. Bottle Opener
 5. Blender Shelf

AVAILABLE MODEL
BAR PKG



SPEED RAIL

Holds bottles for easy access. Comes in two sizes: RAIL-14 and RAIL-19



CONDIMENT TRAY

Keep small items easily accessible. CT



TOWEL HOLDER

A simple bar for hand towels. TH



PANTRY FAUCET

Commercial dual-supply pantry faucet. PANTRY FAUCET



BOTTLE OPENER

Bottle opener/towel rack with integrated cap catcher. BO



SERVING SHELF

Light included. HS-30 (middle shelf and condiment tray not included)



BLENDER SHELF

Fits a standard blender. BS



HIGH SHELF

Includes pot rack and light. True commercial prep. PR-30 (middle shelf not included.)



COLANDER

4" deep stainless colander for easy draining. COLANDER



MIDDLE SHELF

Fits serving shelf and high shelf units. MS (PR-30 or HS-30 required)



ICE PAN

6" deep stainless ice pan slides on sink rails. ICE PAN



VERSA SINK COVER

Protect your sink when not in use. SC-30



BOTTLE WELL

Four bottle wells with tray. BWELL



DISPLAY SHELF

DS



UNDER-THE-COUNTER ICE DRAWER



- Save valuable counter space with the under-counter ice drawer and beverage center
- All stainless steel construction with heavy-duty, 150 lb. capacity drawer sides
- Fully insulated housing and drawer face
- Standard components include: NSF 6" deep stainless steel pan, which holds 32 lbs. of ice and four condiment pans, bottle, and glass storage
- Remove components and use as large ice drawer
- Magnetic rubber gasket and 1" foam insulation

AVAILABLE MODEL

AXE-ID Under-The-Counter Ice Drawer

FOOD WARMING

If friends and family show up late, you can rest assured that they can still enjoy a hot, flavorful meal with Alfresco warming units. The electric warming drawer also serves as a convenient plate and dinnerware heating system prior to serving meals, to help keep your culinary creations warmer, longer.



FOOD WARMER/STEAM TABLE

- Three removable stainless steel food pans with covers
- Slide-out drawer for Sterno-type fuel canisters

AVAILABLE MODELS

AXEFW – Food Warmer
 AXEFWC – Food Warmer Cart Model



ELECTRIC WARMING DRAWER

- 30" wide drawer with electronic temperature control
- Includes four convenient removable stainless steel food pans
- Pans have removable stainless steel lids

AVAILABLE MODELS

AXEWD-30 – 30" Electric Warming Drawer



DESIGN SOLUTIONS BY ALFRESCO

LET ALFRESCO'S PROFESSIONAL DESIGN TEAM HELP MAKE YOUR OUTDOOR DREAM KITCHEN BECOME A REALITY.

Visit the design services page on our website www.alfrescogrills.com/inspiration-planning/design-services to learn more about how Alfresco can assist you in planning your outdoor culinary space, and the requirements for this complementary service. Use the online form to provide your local authorized Alfresco Dealer with the necessary information, and the dealer will submit your project to Alfresco's professional design experts.

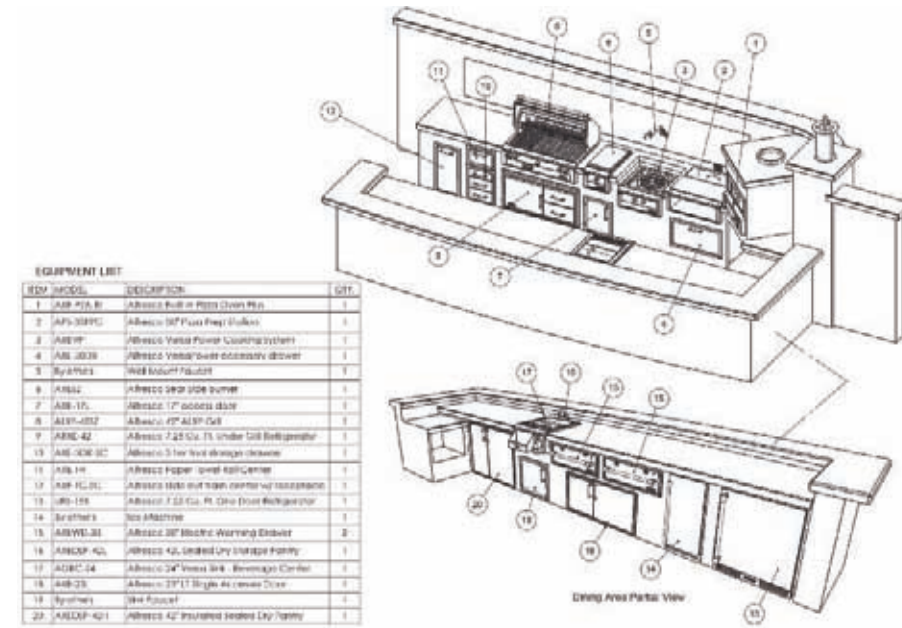
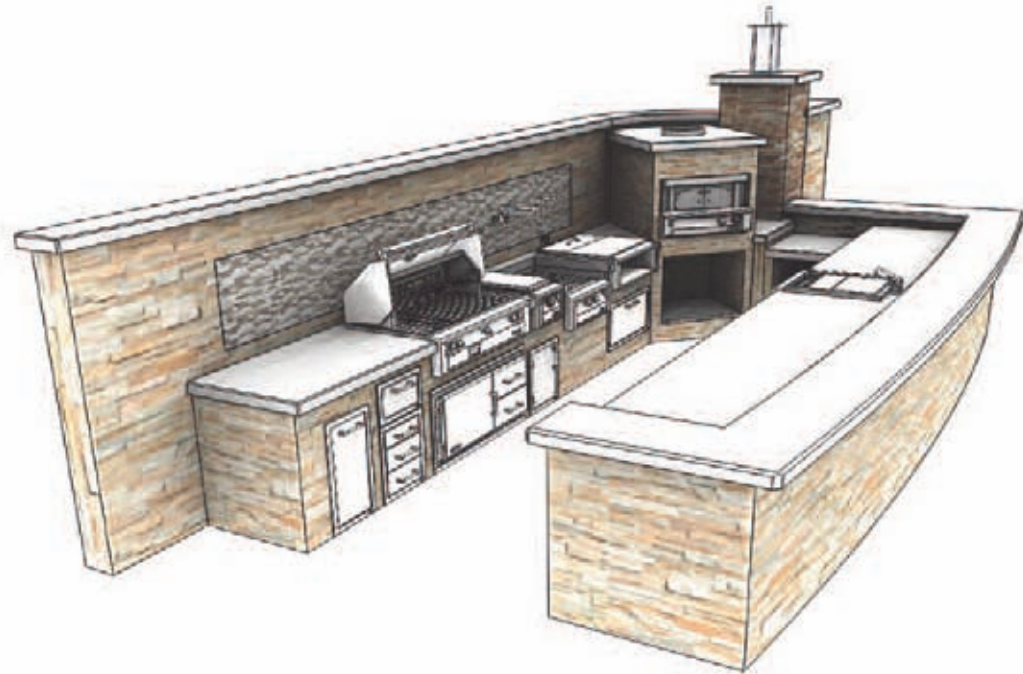

ITEM #	DESCRIPTION	QTY
1	ALFresco 42" Pizza Oven	1
2	ALFresco 30" Power Cooling System	1
3	ALFresco 30" Power Cooling System	1
4	ALFresco 30" Power Cooling System	1
5	Brothers 30" Faucet	1
6	ALFresco 30" Power Cooling System	1
7	ALFresco 17" Access Door	1
8	ALFresco 42" Power Cooling System	1
9	ALFresco 42" Power Cooling System	1
10	ALFresco 42" Power Cooling System	1
11	ALFresco 42" Power Cooling System	1
12	ALFresco 42" Power Cooling System	1
13	ALFresco 42" Power Cooling System	1
14	Brothers 30" Faucet	1
15	ALFresco 42" Power Cooling System	1
16	ALFresco 42" Power Cooling System	1
17	ALFresco 42" Power Cooling System	1
18	ALFresco 42" Power Cooling System	1
19	ALFresco 42" Power Cooling System	1
20	ALFresco 42" Power Cooling System	1

TIPS FOR DESIGNING THE PERFECT OUTDOOR KITCHEN

When designing commercial kitchens, the layout is broken into "zones", and the location of each zone is strategically placed in order to create harmony in the operation to maximize efficiency. It's also important that each zone is ergonomically intuitive; having all the essential components confined to the zone, and keeping everything in arms reach from point of stance. Alfresco has designed all of the pieces necessary to create a fully-functional outdoor kitchen - one in which any professional chef would feel right at home.

TIPS TO CONSIDER WHEN PLANNING:

- o The ideal location for your outdoor kitchen
- o Number of guests you would entertain on a normal basis
- o Are utilities available at the location (e.g. water, gas, electricity)
- o Orientation of outdoor kitchen to house, view, outdoor room, pool
- o Orientation to the sunset (be sure seating doesn't face West)
- o Prevailing wind direction (avoid positioning grill backside to wind)
- o Seating should not be positioned at backside of grill
- o Island enclosure material (insulated jacket required)
- o Refrigeration, sealed dry storage, and sink eliminates trips in and out
- o Let Alfresco's Design Solutions professionals assist in your design
- o Remember, your Alfresco dealer is a great source for ideas and knowledge, helping you to create your dream Alfresco kitchen.

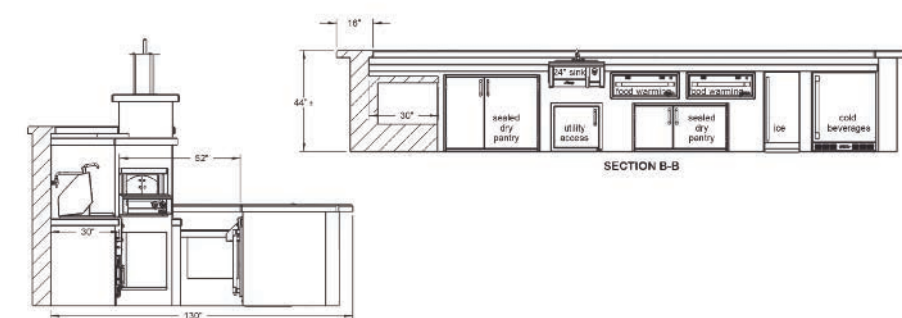
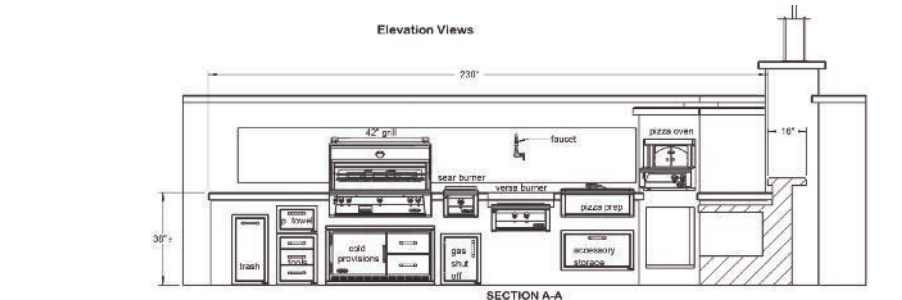
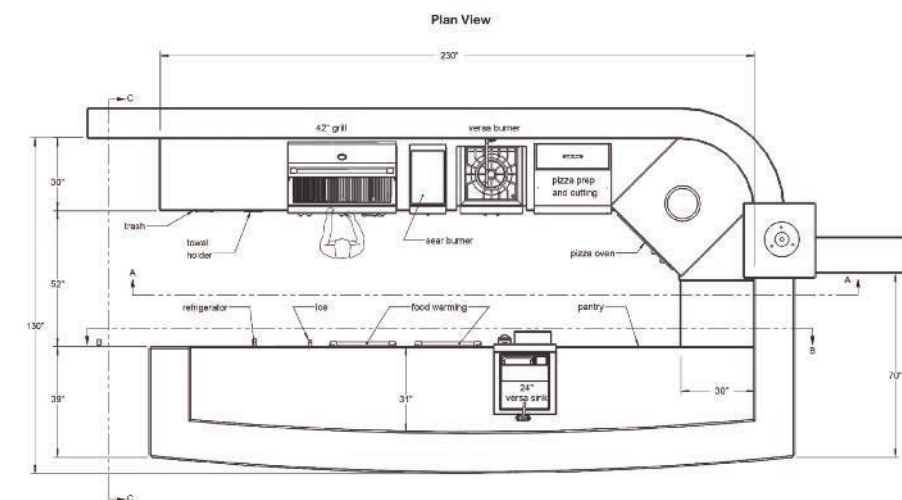
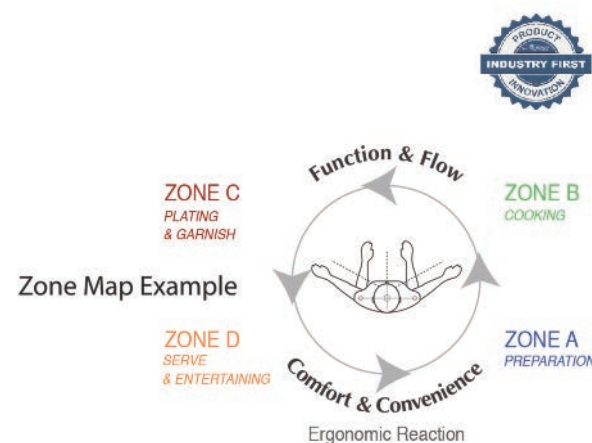

For more details, visit www.alfrescogrills.com/inspiration-planning/design-services



GRILLS AND INSULATED JACKETS

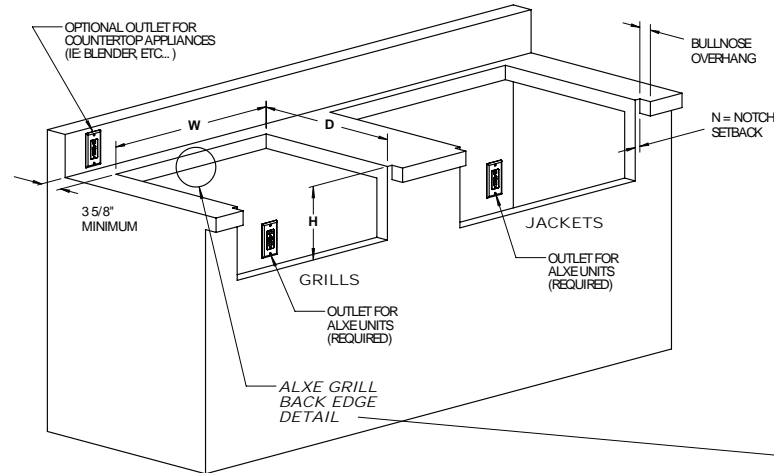

MODEL	CUTOUT DIMENSIONS			NOTCH N	SETBACK S	POWER			GAS LINE
	W	D	H			YES	NO	AMPS	
ALXE-30	28-1/2"	23"	10-1/4"	7/8"		✓		1.44 / 0.91	✓
ALXE-36	34-1/2"	23"	10-1/4"	7/8"		✓		1.44 / 0.91	✓
ALXE-42	40-1/2"	23"	10-1/4"	7/8"		✓		1.44 / 0.91	✓
ALXE-56 / -56 BFG	54-1/2"	23"	10-1/4"	7/8"		✓		1.44 / 0.91	✓
AUJ-30	33-1/4"	24-5/8"	11-1/4"	7/8"		✓			✓
AUJ-36	39-1/4"	24-5/8"	11-1/4"	7/8"		✓			✓
AUJ-42	45-1/4"	24-5/8"	11-1/4"	7/8"		✓			✓
AUJ-56	59-1/4"	24-5/8"	11-1/4"	7/8"		✓			✓

NOTE 1: ALL GRILLS REQUIRE A 1/2" NPT GAS CONNECTION WITH 5" WC FOR NATURAL GAS AND 10" WC FOR LIQUID PROPANE.

NOTE 2: ALL POWER SUPPLIES ARE 115 VAC-10-60 Hz. GFCI RECEPTACLE RECOMMENDED.

NOTE ◆: POWER REQUIREMENT AS STATED ON THE CORRESPONDING GRILL (NOT DUE TO THE AUJ JACKET BY ITSELF).

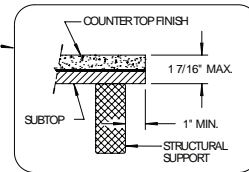

REFRIGERATORS

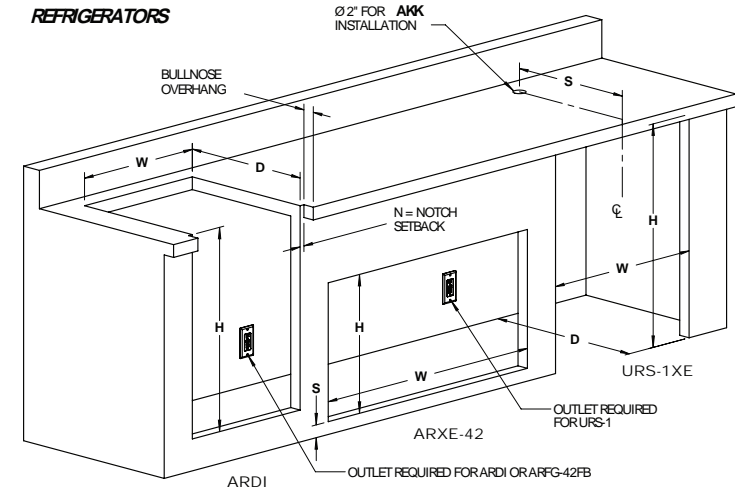

MODEL	DIMENSIONS			NOTCH N	SETBACK S	POWER			DRAIN LINE
	W	H	D			YES	NO	AMPS	
AKK	2" DIAMETER HOLE				21-15/16" ◆				
ARDI	23"	32"	23"	13/16"		✓		5.7	1" Ⓓ
ARXE-42	42-1/2"	21-3/4"	23-1/4"		2" ◆	✓		2.9	
URS-1XE	28-1/2"	35"	23-3/8"			✓		2.8	

NOTE: ALL POWER SUPPLIES ARE 115 VAC-10-60 Hz. GFCI RECEPTACLE RECOMMENDED.

NOTE ◆: SETBACK MEASURED FROM CABINET FRONT (NOT BULLNOSE).

NOTE Ⓓ: DRAIN SIZE IS NPSM - FLOOR DRAIN IN LIEU OF WALL MOUNT IS ACCEPTABLE.

NOTE ◆: SETBACK MINIMUM DISTANCE FROM FLOOR TO ACCOMMODATE ARFG-42 PERIMETER FLANGE.

COUNTERTOP ACCESSORIES

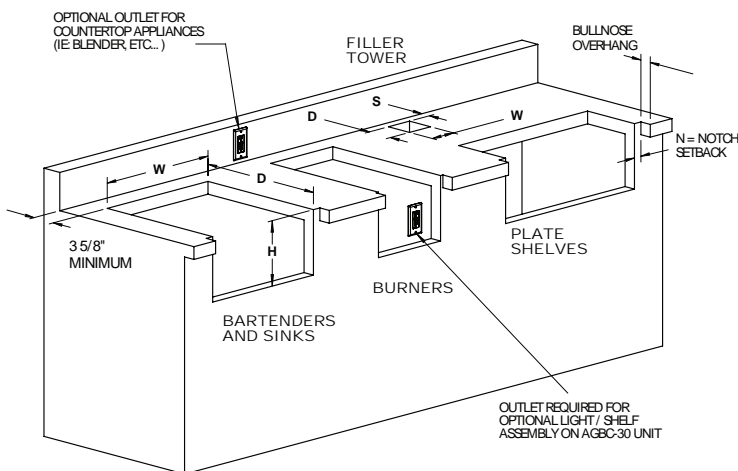

MODEL	CUTOUT DIMENSIONS			NOTCH N	SETBACK S	POWER			GAS LINE	WATER LINE	DRAIN LINE
	W	D	H			YES	NO	AMPS			
AXEVP	21-1/2"	22-1/2"	10-1/4"	1-3/8"		✓		10 mA			
AXEVP-T10	4-1/2"	4-1/2"			1-5/8" ◆	✓	✓			3/8" Ⓓ	
AXEVB-2 / AXESZ	13-1/4"	23"	10-1/4"	1/2"		✓		10 mA	✓		
AXEPW	13-1/4"	23"	10-1/4"	1/2"		✓					
AGBC-14	13-1/4"	23"	9-1/4"	1/2"		✓				1-1/2"	
AGBC-24	22-1/2"	23"	10-1/4"	7/8"		✓				1-1/2"	
AGBC-30	28-1/2"	23"	10-1/4"	7/8"		✓				1-1/2"	
ASK-T	13-1/4"	23"	10-1/4"	1/2"		✓			1/2"	1"	
APS-30P	26-7/8"	15-1/4"	9"	1-7/8"		✓					
APS-30PPC	26-7/8"	22-1/2"	9"	1-7/8"		✓					

NOTE 1: ALL BURNERS REQUIRE A 1/2" NPT GAS CONNECTION WITH 4" WC FOR NATURAL GAS AND 10" WC FOR LIQUID PROPANE.

NOTE 2: ALL WATER LINES ARE 3/8" COMPRESSION OR 1/2" NPSM UNLESS OTHERWISE SHOWN.

NOTE 3: ALL DRAINS SIZES AS SHOWN ARE NPSM STANDARD.

NOTE 4: ALL POWER SUPPLIES ARE 115 VAC-10-60 Hz. GFCI RECEPTACLE RECOMMENDED.

NOTE ◆: THE AGV/PC-T10 POT FILLER TOWER REQUIRES A MINIMUM SETBACK AS SHOWN (OVER AND UNDER THE COUNTERTOP) FROM THE BACK WALL FOR PROPER HARDWARE INSTALLATION.

NOTE Ⓓ: THE AGV/PC-T10 POT FILLER TOWER REQUIRES A 3/8" COMPRESSION WATER LINE AND COMES WITH A 72" LONG COPPER LINE FOR FIELD CONNECTION.

FRONT MOUNTED ISLAND ACCESSORIES, PANTRIES, DOORS, DRAWERS AND COMBO UNITS

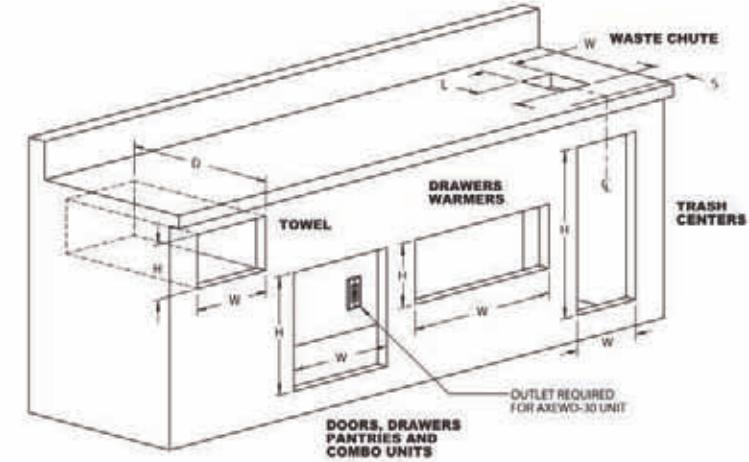

MODEL	CUTOUT DIMENSIONS			SETBACK L	S	POWER			DRAIN LINE
	W	H	D			YES	NO	AMPS	
AXE-17L / -17R / -17E	13-7/8"	18-1/2"	21-5/8"					✓	
AXE-23L / -23R / -23E	19-7/8"	18-1/2"	21-5/8"					✓	
AXE-30 / -30E	27-1/4"	19-1/2"	21-5/8"					✓	
AXE-36 / -36E	33-1/4"	19-1/2"	21-5/8"					✓	
AXE-42 / -42E	39-1/4"	18-1/2"	21-5/8"					✓	
AXE-ODL-5C / -R-5C	29-3/8"	18-5/8"	19-3/8"					✓	
AXE-ODR-5C / -R-5C	14-3/8"	26-1/4"	19-3/8"					✓	
AXE-DTH-L / -R	14-3/8"	26-1/4"	8-1/4"					✓	
AXE-JDRTH-5C	14-3/8"	26-1/4"	19-3/8"					✓	
AXE-2DR-5C	14-5/8"	12-1/4"	19-3/8"					✓	
AXE-3DR-5C	14-5/8"	18-5/8"	19-3/8"					✓	
AXE-30DR-5C	27-3/4"	14"	23-7/8"					✓	
AXE-ID	24"	17-3/4"	25-1/8"					✓	3/8" Ⓓ
AXE-TC-5C	12-1/2"	26-1/4"	18-1/2"					✓	
AXE-TC2D-5C	17-1/4"	26-1/4"	24-1/2"					✓	
AXE-TH	14-1/2"	8-1/2"	7-7/8"					✓	
AXEDSP-30H	28-3/8"	31-3/4"	23-7/8"					✓	
AXEDSP-30L	28-3/8"	19-3/8"	23-7/8"					✓	
AXEDSP-36L	34-3/8"	19-3/8"	23-7/8"					✓	
AXEDSP-42H	40-3/8"	31-3/4"	23-7/8"					✓	
AXEDSP-42L	40-3/8"	19-3/8"	23-7/8"					✓	
APWC	6-1/4"			8-1/2"	4-5/8" ◆			✓	
AXEWD-30	28-1/2"	10"	20-5/8"					✓	3/8"

NOTE: ALL POWER SUPPLIES ARE 115 VAC-10-60 Hz. GFCI RECEPTACLE RECOMMENDED.

NOTE L, S: BACK MEASURED FROM CABINET FACE (NOT BULLNOSE!).

NOTE Ⓓ: 1/2" ID UNIT COMES WITH 36" PLASTIC DRAIN HOSE FOR CONDENSATE/ICE WATER WASTE.

PIZZA BUILT-IN UNIT

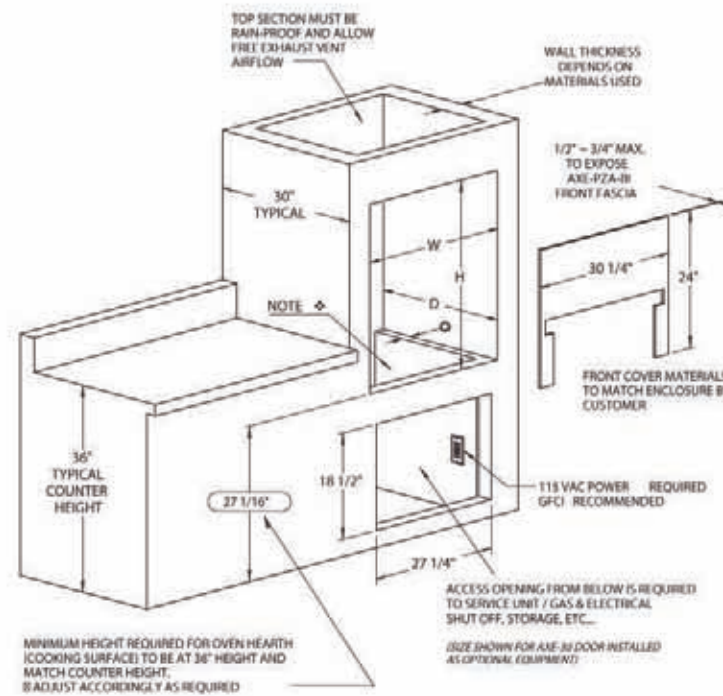

MODEL	DIMENSIONS			NOTCH N	SETBACK S	POWER 115 VAC			DRAIN LINE
	W	H	D			YES	NO	AMPS	
AXE-PZA-BI	30-1/4"	33"	27"					✓	0.3 A NO

NOTES:

Ⓓ: A 2" WIDE LEDGE IS REQUIRED TO SUPPORT THE AXE-PZA-BI UNIT ON BOTH LEFT AND RIGHT SIDES OF THE OPENING.

◆: OPENING AT THE BOTTOM OF THE AXE-PZA-BI UNIT IS REQUIRED FOR COMBUSTION AIR. COUNTERTOP MUST HAVE AIR INTAKE OR VENTILATION FOR PROPER OPERATION.

B: REFER TO SPECIFICATION SHEET AND MANUAL FOR COMPLETE INSTALLATION GUIDELINES.

FOR ADDITIONAL TECHNICAL PRODUCT DETAILS AND INFORMATION, PLEASE VISIT OUR WEBSITE AT WWW.ALFRESCOGILLS.COM



Made in the USA
by Superior Equipment Solutions

1085 Bixby Drive
City of Industry, CA 91745-1704

Toll-Free: 888.383.8800
International: 323.722.7900
Service: (866) 203-5607
fax: 323.726.4700

www.alfrescogrills.com
email: info@alfrescogrills.com

©2019 Superior Equipment Solutions
Catalog design: fusionmarketing.com
Rev. 02.2019

Find us on    

