



STAR

QUALITY SWINGSETS



★ 2022 Catalog ★
PREMIUM VINYL PLAYSETS

Table of Contents



Table of Contents 2-3

Powered By Fun & Adventure 4

FAQ's 5

What Is Star Swings Quality? 6

Quality In The Details 7

Star Gazer Series 8

Star Tower Series 11

Sky Climber Series 18

Space Station Series 26

Double Star Tower Series 30

Our Warranty 35

Build Your Playset 36

Things To Consider 43

Gallery 44

2022 Safety Changes 45

Like Us On Facebook



Free Standing Single Beam
Page 8



Star II E-18
Page 9



Star I E-21
Page 10



Star Cluster E-26
Page 11



Eclipse E-24
Page 12



Falling Star E-33
Page 13



Solar E-32
Page 14



Silver Star E-30
Page 15



Shooting Star Climber E-29
Page 16



Star Explorer E-28
Page 17

Table of Contents



Wishing Star E-50
Page 18



Stardust E-52
Page 19



Play Station
Page 26



Super Star E-70
Page 30



Bright Star E-31
Page 31



Stardust E-53
Page 20



Starburst E-81
Page 21



Play Station E-62
Page 27



Lucky Star E-40
Page 32



Orbit Nebula Climber E-34
Page 33



Comet E-27
Page 22



Galaxy Explorer E-83
Page 23



Galaxy Star E-90
Page 28



Milkyway Climber E-80
Page 34



Nebula E-54
Page 24



Super Nova E-63
Page 25



Playstation E-64
Page 29

Star Quality Swingsets *Powered By Fun & Adventure*



For more than a decade, Star Quality Swingsets has been crafting vinyl playsets and bringing countless hours of enjoyment to children all across the nation. Our family-owned and operated business based in Lancaster County, PA is committed to creating safe and durable playsets for your children or grandchildren.

Studies show that playing outside is crucial to a child's healthy brain and body development. Outdoor play activates the frontal cortex which is responsible for controlling emotions and problem solving. The experience of playing forces the brain to make neurotransmitter connections that are essential to a child's development. The benefits that play has on the body are also undeniably fundamental. Increasing core muscles, refining small motor skills, and increased coordination are just a few ways that play is beneficial to a child's growing body. Additionally, it has been found that attention spans are increased, sensory skills are improved, and better immunity is built! At Star Quality Swingsets, our goal is to build fine quality, affordable playsets to help your child reap all those benefits.

Our playsets are carefully designed to fill all available space with activities that will expand your child's creativity and let the playset become anything they can imagine!

What are you waiting for? Shop our various playset series or get started crafting the playset of your child's dreams today!

We Can Deliver Your Playset!

Your swingset will be delivered partially assembled. All gate openings need to be as wide as the tower of your playset. There is a \$150 charge if we need to return because of inaccessibility.



Frequently Asked Questions

Q. Will the Vinyl Turn Yellowish with Time?

A. No. Here at Star Quality Swingsets we use only high quality vinyl that includes a highly effective UV resistant component specifically engineered to keep it from yellowing.

Q. How Hard is it to Maintain Your Playsets?

A. Star Quality Swingsets loves this question. We love the answer even more! Maintenance is almost unneeded. From time to time, as any outdoor toys do, it needs washed off. However, you don't need harsh cleaners. A hose, glass cleaner, and a soft bristle brush will do the trick!

Q. What Prep is Required Before Installation?

A. We recommend that the site be leveled before delivery, not only for appearance but also for safety. Prepare an area with at least six feet of space on each side of the playset. Not having a properly leveled area will void the warranty.

Q. How Strong is The Vinyl?

A. The vinyl we use has five times the tensile strength of wood and four times the flexibility of wood!

Q. Why Do You Cover the Wood?

A. By covering the wooden structural elements of the playset, it keeps the stability without the maintenance. No one wants to re-stain or re-paint a playset every year. Covering the wood eliminates splinters. It also preserves the wood, which makes our playsets last for many, many fun-filled years to come.



What is *Star Swingsets Quality?*



There are a few things that come to mind when it comes to quality. Here is what we mean when we say Star Swingsets Quality:

- **Safety Obsessed**

When you are looking for a playset for your child the last thing you want to worry about is safety. That's why at Star Quality Swingsets we focus on safety. No splinters, no exposed wood, and child friendly. Our rounded vinyl caps leave no dangerous sharp edges exposed. Non-skid grip tape provides added traction on steps when entering and exiting the tower. Smooth, slip resistant vinyl is the only thing your child needs to come in contact with. Some would say we're obsessed with safety, but this is for your child. Enough said!

- **Stronger than the Rest**

When you think of a typical playset you may not think along the lines of quality. However, a Star Quality Swingset means a playset that will last far longer than your typical, cheaply built, big box store playset. Our splinter-less vinyl encases wolmanized L3 lumber to ensure durability well into your child's teen years. Our premium canvas roof options compete with those used in commercial playgrounds. Our swing beam anchoring system adds extra stabilization to stop shifting during play.

- **Longer Lasting than the Best**

When it comes to durability, we believe in putting our money where our mouth is. That's why all of our playsets have a five year no quibble warranty. We believe in our product. That's why we guarantee you will too! See our warranty page for more details.

CLEANING & CARE

Over years of usage your playset may become dirty looking. To revitalize and clean its appearance use a soft bristled brush, warm water and glass cleaner to gently clean your playset.

With the safety of your child being our number one goal, we offer **vinyl construction** which ensures that there are no splinters or wood treatment chemicals exposed.



Our **soft grip chains** give little hands something comfortable to hold onto.

Double coated zinc chains ensures rust never forms.

By using **high-quality stainless steel fasteners**, we are able to keep rust away and your playset looking like new for years to come.



Our **poly decking** is the most safe and non-splintering for small hands and feet to play on.



The **super heavy-duty slides** are made of thick molded vinyl. Each part of your playset has only the highest of quality materials.

Powder coated corner brackets ensure a rust free structure support.

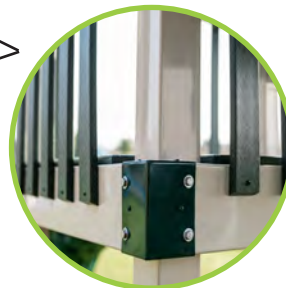

All playsets are built with **pressure-treated wood and encased in a tough vinyl covering**. This will provide safety and beauty.

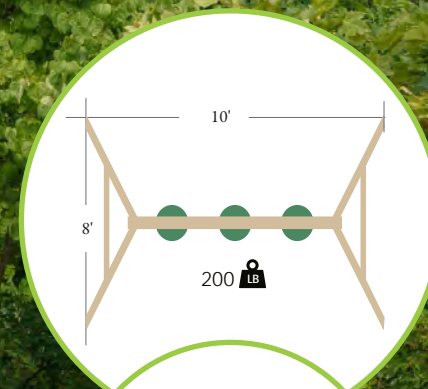

Overall Size:
22' W x 20' L
 Recommended Amount
 Of Mulch: **2 Tons**
 Recommended Amount
 Of Border Material: **84'**

Free Standing Single Beam

Color: White Vinyl, Green Trim, Green Accents

Swing Beam: 3-Position Single Beam w/ Extra End Post

Swings: (3) Belt Swings

Fanback Lawn Swing: White Vinyl, Green Trim, Green Accents

Size: 8' x 8', Playset weighs 300 lbs.

*Fan Back Lawn Swing Option



Star II E-18

Color: Tan Vinyl, Red Trim, Yellow Accents

Tower: 3' x 3' Play Deck, 5' Deck Height

Climber: Entrance Ladder w/ Handrail

Slide: 10' Wonder Wave Slide

Swing Beam: 3-Position Single Beam

Swings: (2) Belt Swings, Trapeze

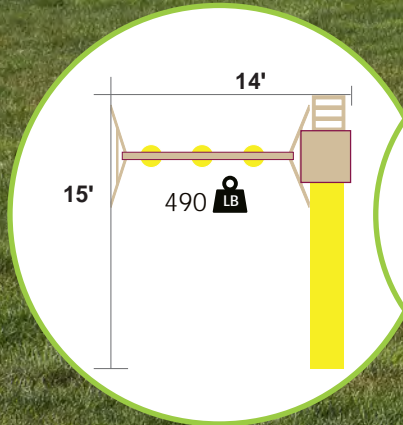

Overall Size:
26' W x 28' L
Recommended Amount
Of Mulch: **3 Tons**
Recommended Amount
Of Border Material: **108'**



Star 1 E-21

Color: Tan Vinyl, Green Trim, Green Accents

Tower: 4' x 4' Play Deck, 5' Deck Height

Climber: Entrance Ladder w/ Handrail, 5' Rock Wall

Slide: 10' Wonder Wave Slide

Swing Beam: 3-Position Single Beam

Swings: (2) Belt Swings, Trapeze

Star Cluster E-26

Color: White Vinyl, Green Trim, Green Accents

Tower: 4' x 4' Play Deck, 5' Deck Height

Roof: 4' x 4' Canopy Roof

Climber: Entrance Ladder w/ Handrail

Slide: 10' Wonder Wave Slide

Swing Beam: 3-Position Single Beam

Swings: (2) Belt Swings, Trapeze

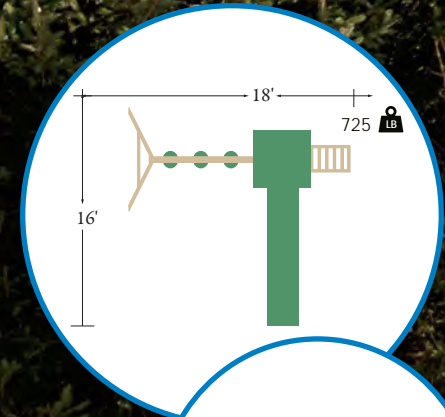

Overall Size:
37' W x 21' L
Recommended Amount
Of Mulch: **3 Tons**
Recommended Amount
Of Border Material: **116'**

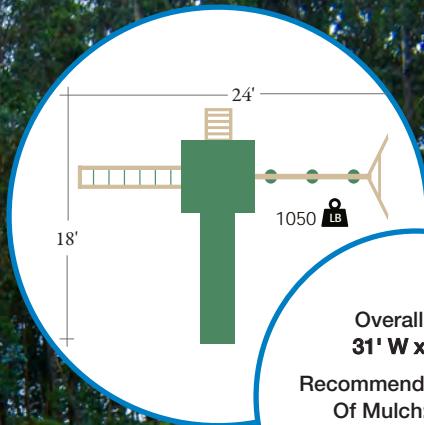

Overall Size:
31' W x 26' L
 Recommended Amount
 Of Mulch: **3 Tons**
 Recommended Amount
 Of Border Material: **114'**

Eclipse E-24

Color: Tan Vinyl, Green Trim, Green Accents

Tower: 5' x 5' Play Deck, 5' Deck Height

Roof: Gable Roof

Climber: Entrance Ladder w/ Handrail,
 8' Monkey Bars

Slide: 10' Wonder Wave Slide

Swing Beam: 3-Position Single Beam

Swings: Belt Swing, Trapeze,
 Safe-T-Glider w/ Single Beam Adapter

Falling Star E-33

Color: White Vinyl, Green Trim, Green Accents

Tower: 5' x 5' Play Deck, 5' Deck Height

Roof: 5' x 5' Vinyl Roof

Climber: Stairs w/ Handrails, 5' Rock Wall, Yardsaver Climber Unit

Slide: (2) 10' Wonder Wave Slides

Swing Beam: 3-Position Single Beam

Swing: Belt Swing, Highback Baby Swing, Uni-Glider w/ 4 Chain Adapter

*Stairs Go on Left Side of Tower

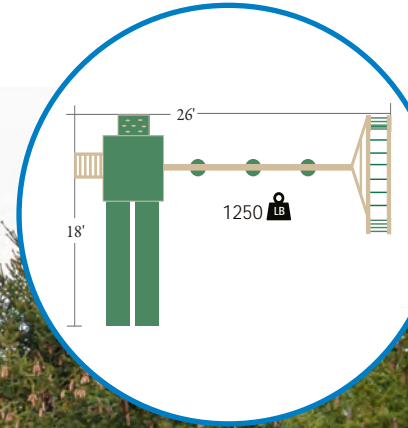

Overall Size:
38' W x 30' L
Recommended Amount
Of Mulch: 4 Tons
Recommended Amount
Of Border Material: 136'



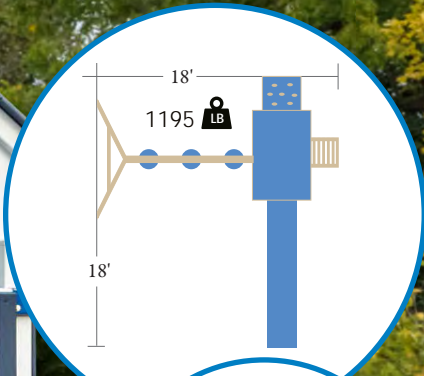

Overall Size:
30' W x 30' L
 Recommended Amount
 Of Mulch: **4 Tons**
 Recommended Amount
 Of Border Material: **120'**

Solar E-32

Color: White Vinyl, Blue Trim, Blue Accents

Tower: 4' x 6' Play Deck, 5' Deck Height

Roof: 4' x 6' Vinyl Roof

Climber: 5' Rock Wall, Entrance Ladder w/ Handrail

Slide: 10' Wonder Wave Slide

Swing Beam: 3-Position Single Beam

Swings: (2) Belt Swings, Baby Swing

Silver Star E-30

Color: Tan Vinyl, Blue Trim, Blue Accents

Tower: 4' x 6' Play Deck, 5' Deck Height

Roof: 4' x 6' Vinyl Roof

Climber: 12' Ramp w/ Rope

Slide: 10' Wonder Wave Slide

Swing Beam: 3-Position Single Beam

Swings: (2) Belt Swings, Highback Baby Swing

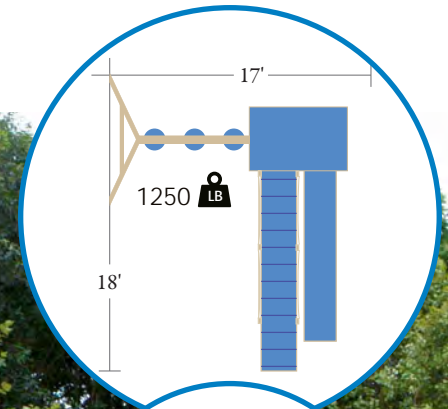

Overall Size:
29' W x 30' L
Recommended Amount
Of Mulch: **4 Tons**
Recommended Amount
Of Border Material: **118'**



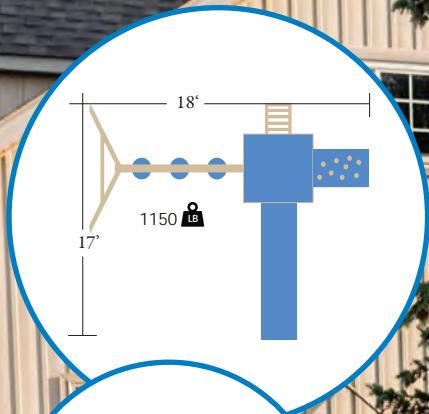

Overall Size:
30' W x 29' L
 Recommended Amount
 Of Mulch: **4 Tons**
 Recommended Amount
 Of Border Material: **118'**



Shooting Star Climber E-29

Color: White Vinyl, Blue Trim, Blue Accents

Tower: 5' x 5' Play Deck, 5' Deck Height

Roof: 5' x 5' Pyramid Roof

Climber: Entrance Ladder w/ Handrail, 5' Rock Wall

Slide: 10' Wonder Wave Slide

Swing Beam: 3-Position Single Beam

Swing: (2) Belt Swings, Trapeze

Add-Ons: Steering Wheel, Binoculars

Star Explorer E-28

Color: Wood Grain Vinyl, Blue Trim, Blue Accents

Tower: 5' x 5' Play Deck, 5' Deck Height

Roof: 5' x 5' Vinyl Roof

Climber: Stairs w/ Handrails

Slide: 10' Wonder Wave Slide, 7' Spiral Slide

Swing Beam: 3-Position Single Beam

Swing: (2) Belt Swings, Uni-Glider
w/ 4 Chain Adapter

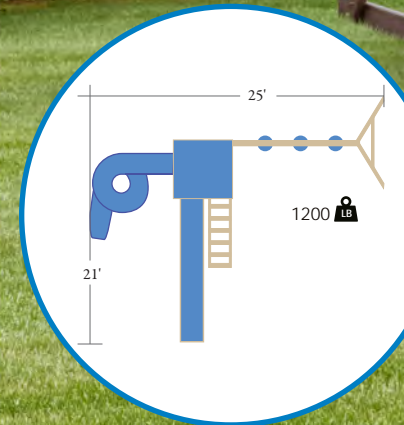

Overall Size:
37' W x 33' L
Recommended Amount
Of Mulch: **5 Tons**
Recommended Amount
Of Border Material: **140'**

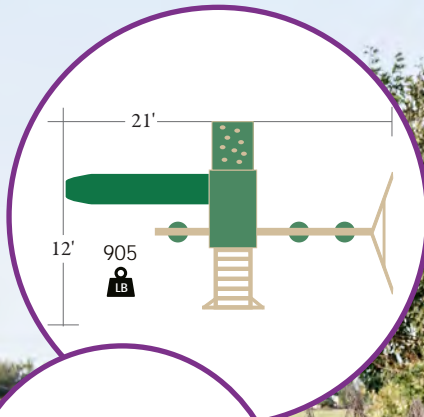

Overall Size:
33' W x 24' L

Recommended Amount
 Of Mulch: **3 Tons**

Recommended Amount
 Of Border Material: **114'**



Wishing Star E-50

Color: White Vinyl, Green Trim, Green Accents
Tower: 3' x 5' Play Deck, 5' Deck Height
Roof: 3' x 9' Canopy Roof
Climber: Entrance Ladder w/ Handrail, 5' Rock Wall
Slide: 10' Wave Slide

Swing Beam: 2 Position Single Beam, 1 Position Extension Arm
Swings: (2) Belt Swings, Trapeze, 3 Chain Tire Swing

Stardust E-52

Color: Tan Vinyl, Green Trim, Green Accents

Tower: 5' x 5' Play Deck, 5' Deck Height

Roof: 5' x 9' Canopy Roof

Climber: Entrance Ladder w/ Handrail,
Rock Wall Cargo Net Combo

Slide: 10' Wonder Wave Slide

Swing Beam: 2-Position Extension Arm

Swings: Belt Swings, 3 Chain Tire Swing, Trapeze

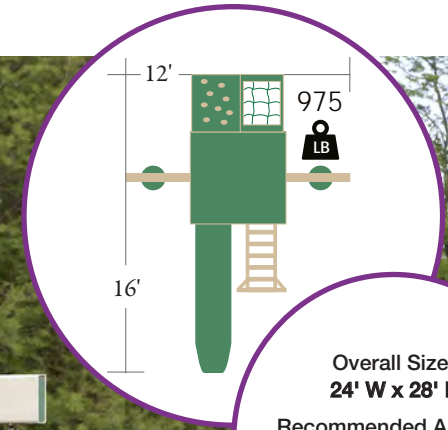

Overall Size:
24' W x 28' L
**Recommended Amount
Of Mulch: 3 Tons**
**Recommended Amount
Of Border Material: 104'**



Overall Size:
37' W x 29' L
 Recommended Amount
 Of Mulch: **4 Tons**
 Recommended Amount
 Of Border Material: **132'**

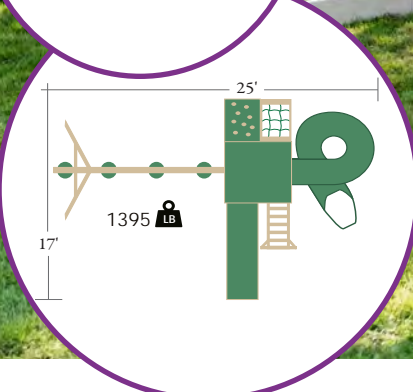

Stardust E-53

Color: Tan Vinyl, Green Trim, Green Accents
Tower: 5' x 5' Play Deck, 5' Deck Height
Roof: 5' x 9' Canopy Roof
Climber: Entrance Ladder w/ Handrail,
 Rock Wall Cargo Net Combo

Slide: 10' Wonder Wave Slide, Spiral Slide
Swing Beam: 4-Position Single Beam
Swings: (3) Belt Swing, Trapeze, 3 Chain Tire Swing
Add-Ons: Captain's Wheel, Binoculars

Starburst E-81

Color: White Vinyl, Blue Trim, Blue Accents

Tower: 5' x 5' Play Deck, 5' Deck Height

Roof: 5' x 9' Canopy Roof

Climber: Entrance Ladder w/ Handrail,
Rock Wall Cargo Net Combo

Slide: 10' Wonder Wave Slide

Swing Beam: 3-Position Single Beam

Swings: Safe-T-Glider, Trapeze, 3 Chain
Tire Swing, Belt Swing

Add-Ons: Ship's Wheel, Telescope



Overall Size:
28' W x 28' L
Recommended Amount
Of Mulch: **3 Tons**
Recommended Amount
Of Border Material: **112'**

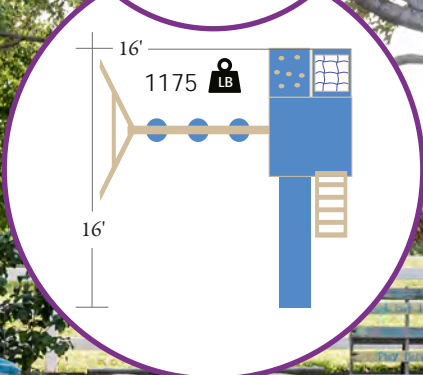

*Due to safety concerns we no longer recommend hanging swings from monkey bars



Comet E-27

Color: Tan Vinyl, Blue Trim, Blue Accents

Tower: 5' x 5' Play Deck, 5' Deck Height

Roof: 5' x 5' Vinyl Roof

Climber: Entrance Ladder w/ Handrail, Rock Wall
Cargo Net Combo, 8' Monkey Bars

Slide: 10' Wonder Wave Slide

Swing Beam: 3-Position Single Beam

Swings: (2) Belt Swings, Trapeze, 3 Chain Tire Swing

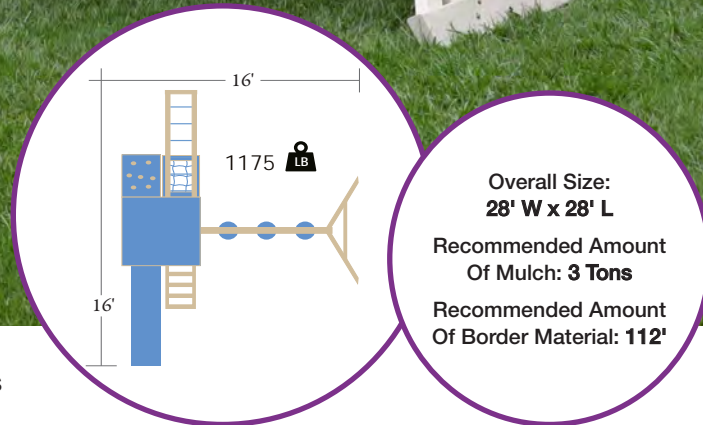

Galaxy Explorer E-83

Color: White Vinyl, Green Trim, Green Accents

Tower: 5' x 5' Play Deck, 5' Deck Height

Roof: 5' x 5' Pyramid Roof

Climber: Entrance Ladder w/ Handrail,
Rock Wall Cargo Net Combo

Slide: 10' Wonder Wave Slide,
Spiral Slide w/ 7' Deck Height Adapter

Swing Beam: 4-Position Single Beam

Swings: Belt Swing, Trapeze, Buoy Trapeze,
Safe-T-Glider w/ Single Beam Adapter, 3 Chain Tire Swing

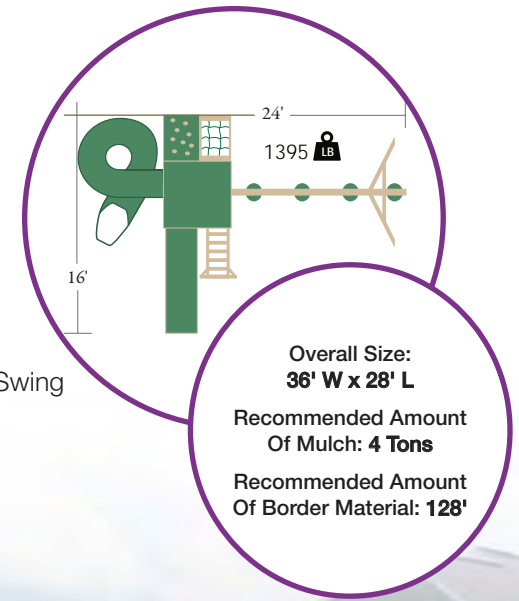

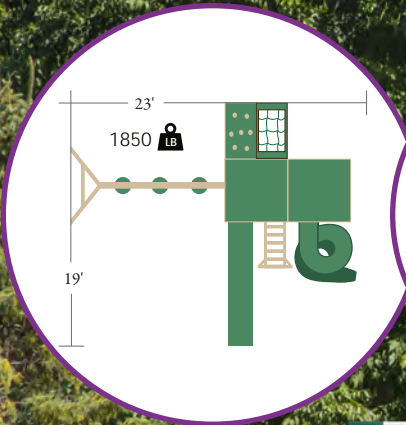

Overall Size:
35' W x 31' L

**Recommended Amount
 Of Mulch: 4 Tons**

**Recommended Amount
 Of Border Material: 128'**



Nebula E-54

Color: White Vinyl, Green Trim, Green Accents
Tower: (2) 5' x 5' Play Decks, 5' & 7' Deck Height
Roof: (2) 5' x 9' Canopy Roofs
Climber: Entrance Ladder w/ Handrail,
 Rock Wall Cargo Net Combo

Slide: 10' Wonder Wave Slide, 7' Spiral Slide,
 2' Deck Height Adapter
Swing Beam: 3-Position Single Beam
Swings: 3 Chain Tire Swing, (2) Belt Swings,
 Safe-T Glider

Super Nova E-63

Color: White Vinyl, Blue Trim, Blue Accents

Tower: 5' x 8' Playhouse Base, 5' x 5' Playhouse, 3' x 5' Play Deck, 5' Deck Height, 5' x 5' A-Frame

Roof: Gable Roof

Climber: Entrance Ladder w/ Handrail, Rock Wall Cargo Net Combo, 12' Ramp w/ Rope

Connector: 6' 6" Bridge w/ Rails

Slide: Turbo Tube Slide, 10' Wonder Wave Slide

Swing Beam: 4-Position Single Beam

Swings: Trapeze, (2) Belt Swings, Hammock Swing, 3 Chain Tire Swing

Add-Ons: Tic-Tac-Toe, Bubble Panel, (2) Windows w/ Screens & Shutters

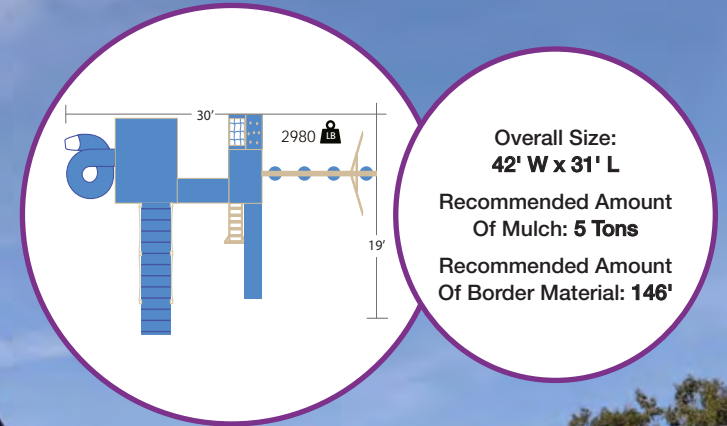

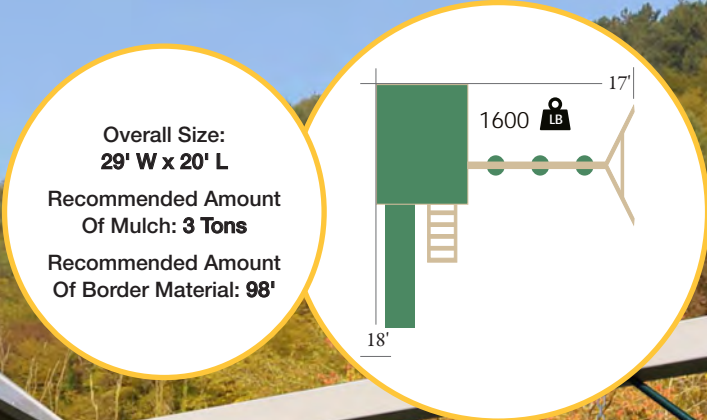

Play Station

Color: Tan Vinyl, Green Trim, Green Accents

Tower: 5' x 8' Base, 5' x 5' Playhouse, 3' x 5' Play Deck, 5' Deck Height

Climber: Entrance Ladder w/ Handrail

Slide: 10' Wonder Wave Slide

Swing Beam: 3-Position Single Beam

Swings: (2) Belt Swings, Trapeze

Add-Ons: (2) Windows w/ Screens & Shutters

Play Station E-62

Color: White Vinyl, Blue Trim, Blue Accents

Tower: 5' x 8' Base, 5' x 5' Playhouse, 3' x 5' Playdeck, 5' Deck Height

Climber: 12' Ramp w/ Rope

Slide: 5' Spiral Slide

Swing Beam: 4-Position Single Beam

Swings: Belt Swing, Trapeze, Baby Swing, Safe-T Glider, 4-Chain Adapter

Add-Ons: (2) Windows w/ Screens & Shutters

Overall Size:
35' W x 31' L

Recommended Amount
Of Mulch: **4 Tons**

Recommended Amount
Of Border Material: **132'**

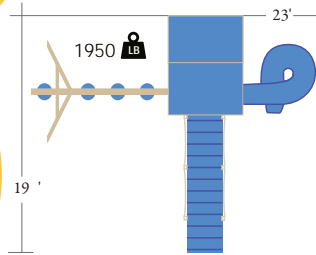

*Playhouse sets are not available in wood grain color



Galaxy Star E-90

Color: Tan Vinyl, Red Trim, Yellow Accents

Tower: 5'x5' Playhouse, 5'x8' Base, 3'x5' Play Deck, 5'x8' Tower, 5' & 7' Deck Heights

Roof: 5'x5' Vinyl Roof

Climber: (2) Entrance Ladders w/ Handrail, 7' Rock Wall

Connector: 6' 6" Bridge w/ Rails

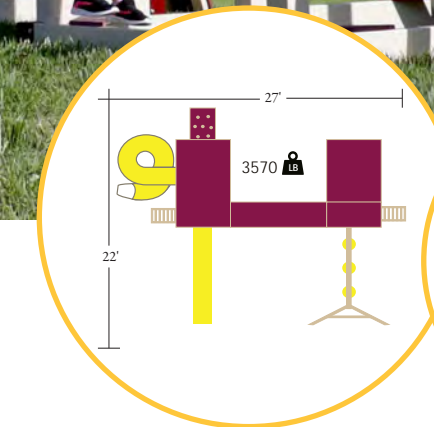

Overall Size:
39' W x 34' L
Recommended Amount
Of Mulch: 5 Tons
Recommended Amount
Of Border Material: 146'

Slide: 7' Spiral Slide, 10' Wonder Wave Side

Swing Beam: 3-Position Single Beam

Swings: (2) Belt Swings, Baby Swing

Add-Ons: 5'x5' Picnic Table, (2) Windows w/ Screens & Shutters

Play Station E-64

Color: Tan Vinyl, Red Trim, Red Accents

Tower: 8' x 8' Base, 5' x 5' Playhouse, 3' x 8' Playdeck, 3' x 5' Playdeck, 5' Deck Height

Climber: Entrance Ladder w/ Handrail, 5' Rock Wall

Slides: 10' Wonder Wave Slide, 5' Spiral Slide, 7' Turbo Slide

Swing Beam: 3-Position Single Beam

Swings: (2) Belt Swings, Trapeze

Add-Ons: (2) Windows w/ Screens & Shutters

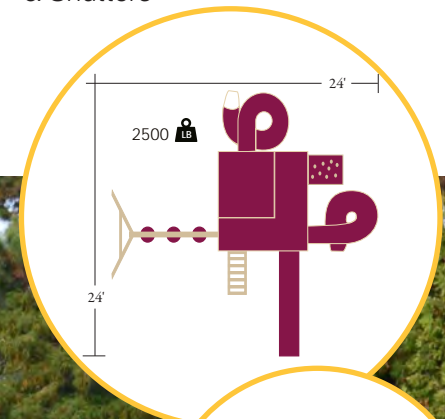

Overall Size:
36' W x 36' L

Recommended Amount
Of Mulch: **5 Tons**

Recommended Amount
Of Border Material: **144'**



*Playhouse sets are not available in wood grain color

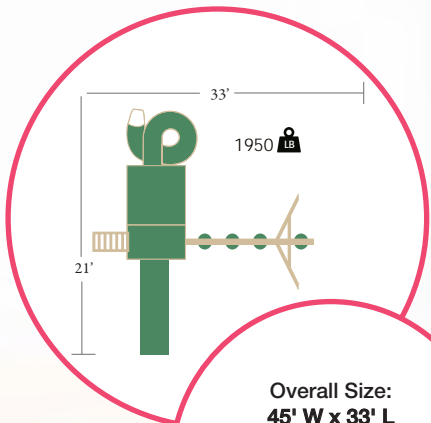

Overall Size:
45' W x 33' L
 Recommended Amount
 Of Mulch: **6 Tons**
 Recommended Amount
 Of Border Material: **156'**



Super Star E-70

- Color:** Tan Vinyl, Green Trim, Green Accents
- Tower:** 5' x 8' Tower, 5' & 7' Deck Heights
- Roof:** 5' x 5' Pyramid Roof
- Climber:** Entrance Ladder w/ Handrail
- Slides:** Spiral Slide, 10' Wonder Wave Slide

- Swing Beam:** 4-Position Single Beam
- Swings:** Safe-T Glider, Belt Swing, Baby Swing, Trapeze
- Add-Ons:** Binoculars, Steering Wheel, Bubble Panel

Bright Star E-31

Color: White Vinyl, Green Trim, Green Accents
Tower: 5' x 8' Play Deck, 5' x 5' Club House w/ (2) Windows & Entrance Door, 3' x 5' Balcony
Roof: 5' x 5' Vinyl Roof
Climber: Entrance Ladder, w/ Handrail

Slide: 10' Wonder Wave Slide
Swing Beam: 3-Position Single Beam
Swings: Belt Swing, Trapeze, Safe-T Glider w/ 4 Chain Adapter
Add-Ons: 2' x 5' Trading Post

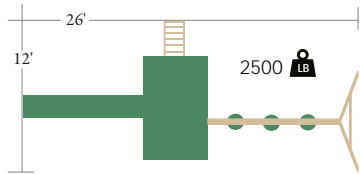

Overall Size:
38' W x 24' L
Recommended Amount
Of Mulch: **4 Tons**
Recommended Amount
Of Border Material: **124'**





Overall Size:
47' W x 42' L
 Recommended Amount
 Of Mulch: **7 Tons**
 Recommended Amount
 Of Border Material: **178'**

Lucky Star E-40

Color: White Vinyl, Green Trim, Green Accents

Tower: 5' x 5' A-Frame Tower w/ 5' x 5' x 7' Tower, 5' x 8' Double Tower, 5' x 5' Tower

Roof: (4) 5' x 5' Vinyl Roofs

Climber: (2) Entrance Ladders w/ Handrail, 12' Ramp w/ Rails, Rock Wall Cargo Net Combo, Monkey Bars

Connector: 6' 6" Crawl Tunnel, 6' 6" Bridge w/ Rails

Slides: 10' Wonder Wave Slide, 7' Spiral Slide, 7' Turbo Slide, 5' Sidewinder Slide

Swing Beam: Extra High 10' 4-Position Swing Beam

Swings: 3 Chain Tire Swing, (2) Belt Swings, Trapeze, Baby Swing

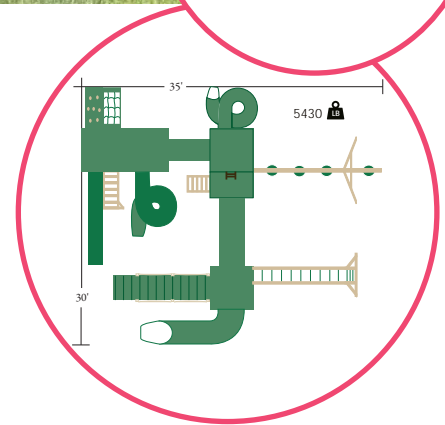

Orbit Nebula Climber E-34

Color: Tan Vinyl, Green Trim, Green Accents

Tower: 6' x 8' Tower, 5' & 7' Deck Heights

Roof: 4' x 6' Vinyl Roof

Climber: Entrance Ladder w/ Handrail, 5' Rock Wall

Slides: Spiral Slide, 10' Wonder Wave Slide

Swing Beam: 3-Position Single Beam

Swings: (2) Belt Swings, Safe-T Glider, Hammock Swing

Add Ons: 4' x 6' Ground Level Deck

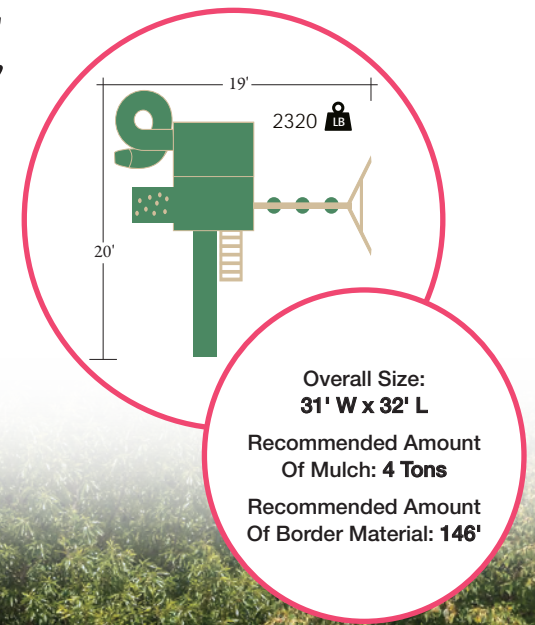

*Due to safety concerns we no longer recommend hanging swings from monkey bars



Milkyway Climber E-80

Color: White Vinyl, Blue Trim, Blue Accents

Towers: (2) 5' x 8' Towers, 5' & 7' Deck Heights

Roof: (2) 5' x 5' Pyramid Roof

Climber: Entrance Ladder w/ Handrail

Connector: 6' 6" Bridge w/ Rope, 6' 6" Crawl Tunnel

Slide: Spiral Slide, 10' Avalanche Slide

Swing Beam: 3-Position Single Beam

Swings: Safe-T Glider, (2) Belt Swings

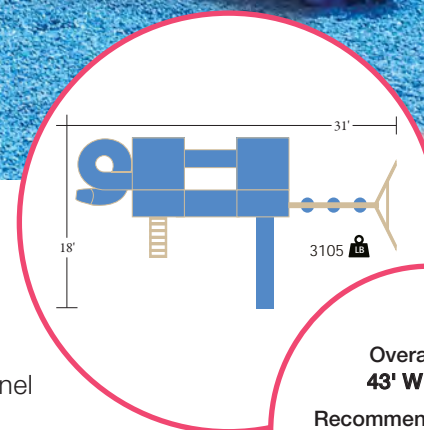

Overall Size:
43' W x 30' L
 Recommended Amount
 Of Mulch: **5 Tons**
 Recommended Amount
 Of Border Material: **146'**



Warranty Information

STAR QUALITY SWINGSETS WARRANTY

Subject to ordinary residential use and proper installation by a certified Star Quality Swingsets installer, Star Quality Swingsets warrants to the original purchaser at the original installation address, that the structural components of the playground systems, such as the PVC plastic lumber and wood components, are covered by a 20-year warranty. In addition, all canopies, slides, metal components, swings, and accessories are warranted for five years from date of original purchase.

Effects of normal wear and tear, improper maintenance or abuse are not covered by this warranty. All damage resulting from acts of nature are not covered by this warranty.

Star Quality Swingsets reserves the right to request proof in the form of photos or physical evidence of defective product. Customer agrees to pay for all shipping or other costs involved in returning said defective product for inspection. Star Quality Swingsets will repair or replace the defective products at its own discretion. If this is deemed impractical, we will reimburse the original purchaser for the value of the defective piece.

All of the above expressed applies ONLY to sets that are installed by an authorized Star Quality Swingsets installer and used in a normal residential environment. We ALWAYS advise adult supervision while your child enjoys their play set. Please make sure your child is instructed to keep a safe distance from all moving equipment and parts.



Guide to Building Your Playset

Step 1: Choose Your Tower



3' x 3'
Tower



4' x 4'
Tower



4' x 6'
Tower



5' x 5'
Tower



5' x 8'
Tower



6' x 8'
Tower



5' x 5'
A-Frame



5' x 8'
Playstation



3' x 5'
A-Frame



8' x 8'
Playstation

Guide to Building Your Playset

Step 2: Choose Your Roof

Available in Blue, Red, or Green

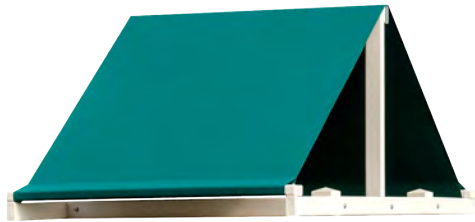

Canvas Roof

Available in 3' x 9', 5' x 9'



Pyramid Roof

Available in 4' x 4' and 5' x 5'



Vinyl Roof

Available in 4' x 4', 4' x 6', 5' x 5'



Gable Roof

Available in 4' x 4' and 5' x 5'

Step 3: Choose Your Climbers

Vinyl Available In White, Tan, or Wood Grain

Poly Available In Green, Red, or Blue



Entrance Ladder

Features Non-Slip Steps & 1 Handrail



Stairs

Standard w/ 2 Handrails



Ramp

Comes w/ Your Choice of Rope or Rails



Rock Wall

5' or 7', Comes w/ Rope for Easy Climbing



Mounting Ladder (Optional)

Attaches to Tower to Dismount from Climbing Beam



Cargo Net

5' Deck Height

Guide to Building Your Playset

Step 4: Choose Your Connectors

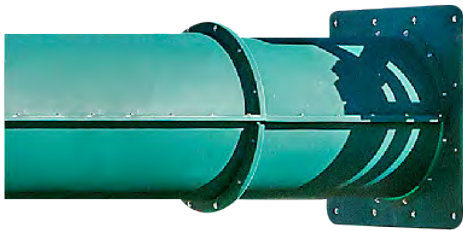

6' 6" Crawl Tunnel



6' 6" Bridge

Comes w/ Your Choice of Rope or Rails

Step 5: Choose Your Slides

Available in Blue, Red, Green or Yellow



10' Wonder Wave

For 5' Deck



10' Avalanche

For 5' Deck



Sidewinder Slide

For 5' Deck



Turbo Slide

For 7' Deck or for Use w/ Step
& Slide Adapter on 5' Deck



Spiral Slide

Available for 5' &
7' Deck Heights



Slide & Step Adapter

Use to Add 7' Spiral Slide or
14' Turbo Slide to 5' Deck

Guide to Building Your Playset

Step 6: Choose Your Swing Beam



4-Chain Adapter



2-Position Single Beam



3-Position Single Beam



4-Position Single Beam

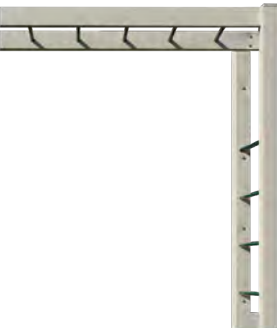

8' Monkey Bars



1-Position Extension Arm



2-Position Extension Arm



Yard-Saver Climber Unit

Guide to Building Your Playset

Step 7: Choose Your Swings

Available in Blue, Red, Green or Yellow



Belt Swing



Trapeze



Baby Swing



**Highback
Baby Swing**



Buoy Ball



Buoy Trapeze



**3 Chain
Tire Swing**



**4 Chain
Tire Swing**



Safe-T-Glider



Hammock Swing
Print & Style May Vary

Step 8: Choose Your Add-Ons



Bubble Panel
Green, Blue, or Red



Captain's Wheel
Green, Blue, or Red



Steering Wheel
Green, Blue, or Red



Telescope
Green, Blue, or Red



Megaphone
Green, Blue, or Red



Binoculars
Green, Blue, or Red



Tic-Tac-Toe Game



Picnic Table
4'x4', 4'x6', 5'x5', or 5'x6'

Guide to Building Your Playset

Color Choices

VINYL COLORS



Tan



White



Wood Grain

TRIM COLORS



Blue



Green



Red

Finishing Touches

RUBBER MULCH

Star Quality Swingsets' rubber mulch is highly durable and does not decompose, compact, or require annual top-up over its lifetime. Our processing methods have been perfected over the last 20+ years, yielding the cleanest, safest rubber mulch available today. It's no wonder our rubber mulch is the top choice of schools, public playgrounds and homeowners.



Green



Brown



Blue



Red



Black

Guide to Building Your Playset

Finishing Touches

Engineered Wood Fiber (EWF)

Engineered wood fiber is a popular choice for projects with initial budget constraints. EWF does require ongoing raking and occasional topping off during its lifetime due to compaction and decomposition. This maintenance will help ensure the correct material depth of the playground wood fibers for compliance with safety and accessibility standards. Once the newly installed EWF has settled, it forms a “knitted” layer that is designed to support a variety of mobility devices including wheelchairs, crutches, and walkers.



Rubber Mulch Border - 6" H x 4' L



Tan



Gray

Geotextile Fabric - Weed Barrier

This barrier is the premium weed guard available for play sets. We offer it to our customers with every rubber mulch and EWF installation. It allows air and water to penetrate through to keep it worry-free of puddling, mudding and even weed growth on the playground.



	Rubber Mulch	Engineered Wood Fiber
COST-EFFECTIVE	●	○
EASY TO INSTALL	●	●
SAFETY-RATED UP TO 12 FT	●	○
DOESN'T REQUIRE ANNUAL TOP-UP	●	○
DOESN'T PROMOTE GROWTH OF MOLD & FUNGUS	●	○
DOESN'T ATTRACT ANIMALS & INSECTS	●	○
DOESN'T ABSORB WATER	●	○
DOESN'T DECOMPOSE	●	○
DOESN'T COMPACT	●	○
DOESN'T FREEZE & HARDEN	●	○

Things To Consider

Space For The Playset

It's very important to keep in mind the proper safety zone precautions. The industry standard is 6' of open space around the entire playset. This space ensures your child has enough room to run, swing and play safely.

Location

Since safety is the #1 priority, it is imperative to keep your playset out of range of any electrical wires, clotheslines and low lying tree branches. Consider installing your playset in clear sight of the house for easy parental supervision. Installing the playset in a shady spot in the yard can help avoid hot slides and minimize sunburns!

Many homeowner's associations have guidelines about how close your playset can be to your home, property lines, sheds and pools. Make sure you are familiar with their rules and regulations before purchase and installation.

Safety Surfacing

While rubber mulch is considered to be the safest option for underneath of the playset, it is not the only option. Playground surfacing falls into two categories. First, loose-fill materials such as engineered wood fiber, rubber mulch, sand and pea gravel. The second category is unitary surfacing. Unitary surfacing consists of poured rubber, grass and artificial grass or turf. Every playground has different needs so it is important to take into consideration budget, maintenance and who will be playing on the set. To learn more about the safety surfacing options available at Star Quality Swingsets, check out our 'Guide to Building Your Playset'.

Who Will Be Playing On The Playset

Consider age range when choosing the perfect playset for your family or organization. For babies and toddlers, ground level playhouses, baby swings, and bubble panels provide easy and fun entertainment. Some components that are fun for preschool age children and up are enclosed slides, belt swings and picnic tables. Some components require stronger motor skills and would be difficult for children under five such as rock walls and cargo nets. Children between the ages of five and eight should be able to balance, jump and engage in more challenging play. Adding items such as monkey bars, a trapeze and 14' slides keeps them learning and active. As your child grows, we recommend modifying your playset to their abilities. Switching out swings and adding fun items is an easy and cost efficient way to make sure your child is getting the most out of the playset.



Gallery



2022 Safety Changes

*All Entrance Ladders have
new style of handrail*



*All Sky Climber Series
playsets come with one new
style of handrail*





Authorized Dealer



STAR

QUALITY SWINGSETS