



WARMING TRENDS BURNERS

BURNERS | PLATES | PANS | ACCESSORIES

TABLE OF CONTENTS

WARMING TRENDS

Firestorm Steel Log	19
Universal Paver Kits	20
Circular Plates & Pans	22
Square Plates & Pans	24
Original Crossfire™ Burners	26
Octagonal Crossfire™ Burners	27
Rectangle Plates & Pans.....	28
Tree-Style Crossfire™ Burners.....	30
H-Style Crossfire™ Burners	32
Linear Crossfire™ Burners.....	33
Ignition Kits.....	34
29 ¼" Burner System	40

AMERICAN FIREGLASS

Fire Pit Rings & Pans	42
-----------------------------	----

ACCESSORIES

Lava Rock	36
Log Sets.....	36
Fireglass	37
Burner Covers	38
Wind Guards.....	41
Media Calculator.....	44

LITERATURE

Item No	Description	Retail
AFG-CATALOG	American Fireglass Catalog	N/C
ERFG	Emilyrose Fireglass	N/C
WTTRI	Warming Trends	N/C

WARMING TRENDS[®]



TWICE THE FLAME



ALL BRASS COMPONENTS



LIFETIME WARRANTY



MADE IN THE USA

**EMPIRE DISTRIBUTING STOCKS A WIDE VARIETY OF WARMING TRENDS CROSSFIRE™ BURNERS
UP TO 48" IN DIAMETER - CAN SHIP WITHIN 48 HOURS.**

Six Easy Steps to Purchasing

1. Measure the opening of your fire pit.
2. Choose the corresponding Plate or Pan size.
(Pans come standard with a 2" welded sidewall.)
3. Choose Burner and Fuel Type.
(Natural Gas or Liquid Propane)
4. Choose your Ignition System: match lit, push button, or on/off switch.
5. Choose Electronic Add-Ons: remote control options, dial timers, and emergency stops.
6. Complete the look with Accessories: ceramic logs, lava rock, volcanic stone or fire glass.

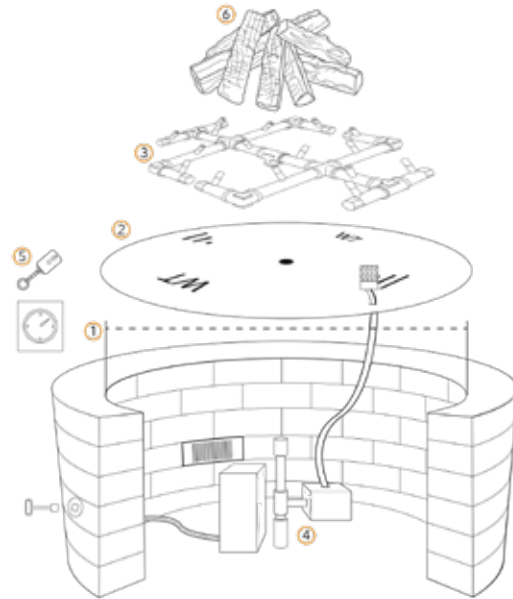

Standard Ring Burner with 180k BTU's

CFB180 CROSSFIRE Brass Burner
with 180k BTU's



Steel Log Kit



FIRESTORM STEEL LOG KIT

Includes: 32" Hand-crafted Steel Gas Log, CFBL150 Burner, and 38" x 10" Aluminum Plate

Item No	Description	Retail
FSL32LP	Firestorm Steel Log Kit, LP	\$1,249
FSL32NG	Firestorm Steel Log Kit, NG	\$1,249

(Firestorm log is not compatible with push button or electronic ignition.)



Scan Code to see
Firestorm Steel Logs Burning Video

ACCESSORIES

Item No	Description	Retail
FLKV34-12	Match Light Key Valve Kit (Includes: 36" L x 3/4" Diameter Whistle Free Flex Line; 3/4" Connector; 3/4" Key Valve; 12" & 3" Key)	\$170
FP.EXT	12" Adjustable Key Valve Extension with 1/2" Banded Coupling	\$15
FPVK	Fire Pit Vent Kit, Black - Set of 2 (3 3/4" x 12", includes hardware)	\$51
BLR	Lava Rock 1" - 1 1/2", Black (40 lb bag)	\$45

For a list of media, see pages 36-37 of the Fire Pit Burner section. For all other accessories, see page 34.

FEATURES

- Handcrafted, one-of-a kind steel gas log
- Integrated burner compounds the effects of the Crossfire Brass Burner, creating a beautiful flame pattern
- Simple and easy installation
- Kit includes Crossfire Brass Burner (for NG or LP), Firestorm Steel Log, and aluminum plate

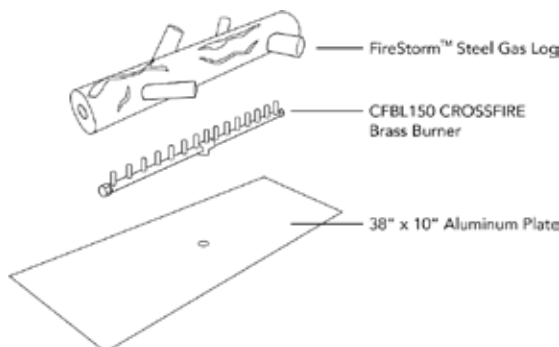

Firestorm Log Detail

Warming Trends® Universal Paver Kits are a complete* Match Light Fire Feature package that is designed to fit into paver block manufactured fire pit kits. This eliminates the need to special order a custom sized burner plate. Universal Paver Kits provide an easy and simple installation.

Confirm the interior dimensions of your fire pit to select the matching Warming Trends® Universal Paver Kit.

*Media and Vent Kit not included

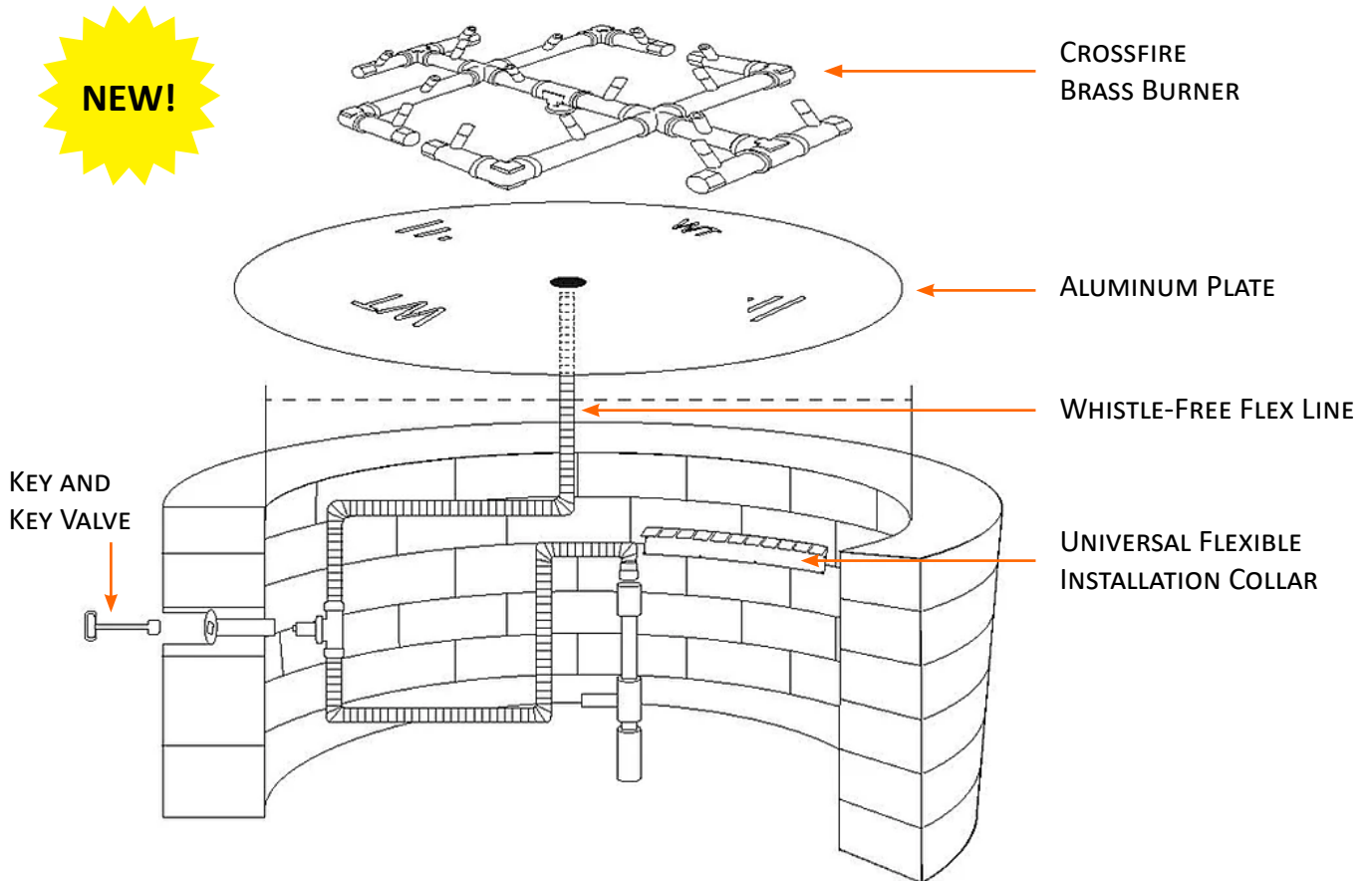

UNIVERSAL PAVER KITS - FOR CIRCULAR OPENINGS

Includes: CROSSFIRE® Brass Burner, Aluminum Plate, Flex Line Kit, Key, Key Valve, Key Valve Extension, and Universal Flexible Installation Collars

Item No - NG	Item No - LP	Opening Dimensions	Burner	Plate	Key Valve Kit	Collars	Lava Rock Required	Retail
UPK120C-2325NG	UPK120C-2325LP	23" - 25"	CFB120	23"	FLKV12	4	39 lbs	\$821
UPK120C-2628NG	UPK120C-2628LP	26" - 28"	CFB120	26"	FLKV12	4	49 lbs	\$855
UPK180C-2931NG	UPK180C-2931LP	29" - 31"	CFB180	29"	FLKV34-12	5	60 lbs	\$1,196
UPK240C-3537NG	UPK240C-3537LP	35" - 37"	CFB240	35"	FLKV34-12	6	86 lbs	\$1,439
UPK240C-3941NG	UPK240C-3941LP	39" - 41"	CFB240	39"	FLKV34-12	7	105 lbs	\$1,553

ACCESSORIES

Item No	Description	Retail
PBIK-PBMBR	Push Button Ignition Kit w/ Paver Block Mounting Bracket (for easy mounting of PBIK into paver kit)	\$136
BLR	Lava Rock 1" - 1 1/2", Black (40 lb bag)	\$45
FPVK	Fire Pit Vent Kit - Set of 2 (3 3/4" x 12", includes hardware)	\$51

(See page 36-37 of Fire Pit Burner Section for full line of media.)

SQUARE UNIVERSAL PAVER KITS

Warming Trends® Universal Paver Kits are a complete* Match Light Fire Feature package that is designed to fit into paver block manufactured fire pit kits. This eliminates the need to special order a custom sized burner plate. Universal Paver Kits provide an easy and simple installation.

Confirm the interior dimensions of your fire pit to select the matching Warming Trends® Universal Paver Kit.

*Media and Vent Kit not included

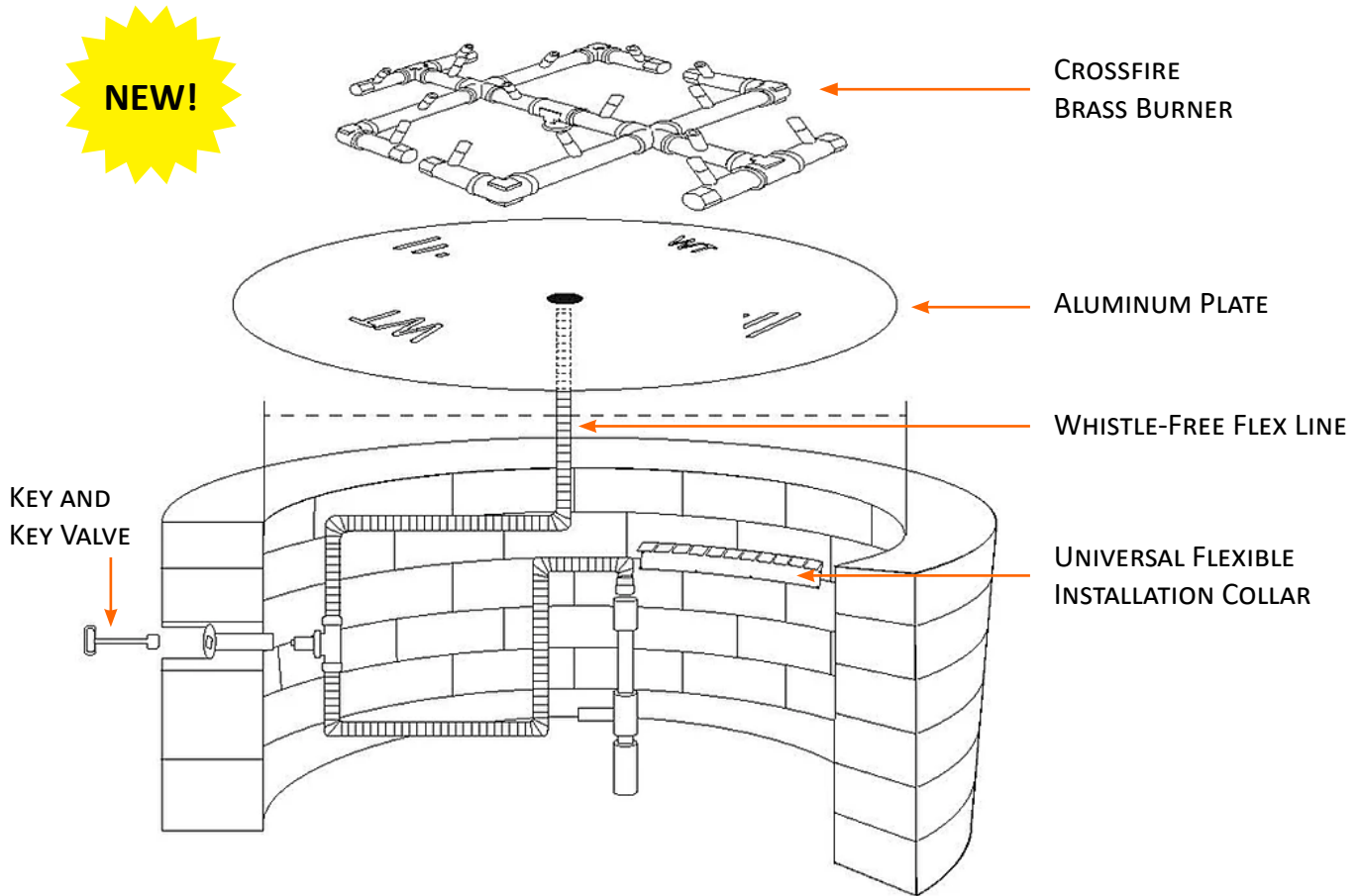

UNIVERSAL PAVER KITS - FOR SQUARE OPENINGS

Includes: CROSSFIRE® Brass Burner, Aluminum Plate, Flex Line Kit, Key, Key Valve, Key Valve Extension, and Universal Flexible Installation Collars

Item No - NG	Item No - LP	Opening Dimensions	Burner	Plate	Key Valve Kit	Collars	Lava Rock Required	Retail
UPK120S-2325NG	UPK120S-2325LP	23"-25"	CFB120	23"	FLKV12	4	46 lbs	\$821
UPK120S-2628NG	UPK120S-2628LP	26"-28"	CFB120	26"	FLKV12	4	62 lbs	\$855
UPK180S-2931NG	UPK180S-2931LP	29"-31"	CFB180	29"	FLKV34-12	5	75 lbs	\$1,196
UPK240S-3537NG	UPK240S-3537LP	35"- 37"	CFB240	35"	FLKV34-12	6	107 lbs	\$1,439
UPK240S-3941NG	UPK240S-3941LP	39"- 41"	CFB240	39"	FLKV34-12	7	131 lbs	\$1,553

ACCESSORIES

Item No	Description	Retail
PBIK-PBMBR	Push Button Ignition Kit w/ Paver Block Mounting Bracket (for easy mounting of PBIK into paver kit)	\$136
BLR	Lava Rock 1" - 1 1/2", Black (40 lb bag)	\$45
FPVK	Fire Pit Vent Kit - Set of 2 (3 3/4" x 12", includes hardware)	\$51

(See page 36-37 of Fire Pit Burner Section for full line of media.)

CIRCULAR PLATES

Select a Warming Trends Plate or Pan, Crossfire™ Burner and Ignition Kit (see pages 34-35) to make a complete burner system. Add your Media/Logs.

Warming Trends heavy duty aluminum mounting plates provide a solid ventilated/drainage surface to support your burner and your media choice. This plate is fitted with the proper gas supply connection point to attach the burner to the plate.



Circular Plate

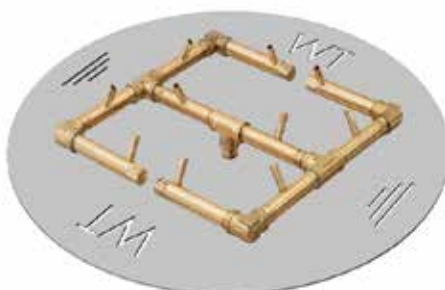

Circular Plate shown with CFB120 Burner
Burner Sold Separately, See page 26-27

NOTE: It is recommended to incorporate 1 vent on at least two opposing sides (2 vents total) at a minimum size of 18 sq. inches each (Example: 3"x 6" or larger). Installation of the vents in the mid to lower area of the enclosure is recommended. Always consult with local municipality regarding any local code requirements. See page 34 for Vent Kit, item number FPVK.

CIRCULAR PLATES

Item No	Description	Inlet	Retail
ALPL18C	18" Aluminum Plate, Circular	1/2"	\$98
ALPL24C	24" Aluminum Plate, Circular	1/2"	\$188
ALPL29.25C	29.25" Aluminum Plate, Circular	1/2"	\$307
ALPL30C	30" Aluminum Plate, Circular	1/2"	\$252
ALPL35.5C	35.50" Aluminum Plate, Circular	1/2"	\$463
ALPL36C	36" Aluminum Plate, Circular	1/2"	\$379
ALPL42C	42" Aluminum Plate, Circular	3/4"	\$506
ALPL48C	48" Aluminum Plate, Circular	3/4"	\$651
ALPL60C*	60" Aluminum Plate, Circular	3/4"	\$997

CIRCULAR PLATES - CUT TO FIT (Note: Cut to Fit plates are not returnable.)

Item No	Description	Inlet	Retail
ALPL1218C	12.00"-17.99" Aluminum Plate, Circular	1/2"	\$147
ALPL1824C	18.01"-23.99" Aluminum Plate, Circular	1/2"	\$240
ALPL2430C	24.01"-29.99" Aluminum Plate, Circular	1/2"	\$307
ALPL29.25C	29.25" Aluminum Plate, Circular	1/2"	\$307
ALPL3036C	30.01"-35.99" Aluminum Plate, Circular	1/2"	\$463
ALPL3642C	36.01"-41.99" Aluminum Plate, Circular	3/4"	\$555
ALPL4248C	42.01"-47.99" Aluminum Plate, Circular	3/4"	\$699
ALPL4860C*	48.01"-59.99" Aluminum Plate, Circular	3/4"	\$1,073
ALPLCUST*	Custom Aluminum Plate (We can manufacture any custom shape or size.)		TBD

INSTALLATION COLLAR

Installation collars provide support for the aluminum plate, allowing for any size plate to be used for a range of sizes. This system will allow a 3" range added on to any plate size. (Example: a 30" plate can now fit up to a 33" opening)

Item No	Description	Retail
COLLAR	19" Universal Flexible Aluminum Installation Collar (order multiples depending on the size of the fire pit)	\$27



19" Collar

*Special Order

When ordering aluminum plates, please specify the exact size plate you would like for your project. Each plate is specifically cut for each order. Please allow 48 hours for shipping.

CIRCULAR PANS

Select a Warming Trends Plate or Pan, Crossfire™ Burner and Ignition Kit (see pages 34-35) to make a complete burner system. Add your Media/Logs.

Using the Warming Trends heavy duty aluminum mounting pan with 2" sidewalls will provide a solid ventilated/drainage surface to support your burner and your media choice. This pan is fitted with the proper gas supply connection point to attach the burner to the pan.



Circular Pan with 2" Sidewall



Circular Pan shown with CFB120 Burner Burner Sold Separately, See page 26-27

NOTE: It is recommended to incorporate 1 vent on at least two opposing sides (2 vents total) at a minimum size of 18 sq. inches each (Example: 3"x 6" or larger). Installation of the vents in the mid to lower area of the enclosure is recommended. Always consult with local municipality regarding any local code requirements. See page 34 for Vent Kit, item number FPVK.

CIRCULAR PANS (with 2" Welded Sidewalls)

Item No	Description	Inlet	Retail
ALPAN18C	18" Aluminum Pan, Circular	1/2"	\$218
ALPAN24C	24" Aluminum Pan, Circular	1/2"	\$275
ALPAN30C	30" Aluminum Pan, Circular	1/2"	\$347
ALPAN36C	36" Aluminum Pan, Circular	1/2"	\$486
ALPAN42C	42" Aluminum Pan, Circular	3/4"	\$609
ALPAN48C	48" Aluminum Pan, Circular	3/4"	\$749
ALPAN60C*	60" Aluminum Pan, Circular	3/4"	\$1,099

CIRCULAR PANS - CUT TO FIT (with 2" Welded Sidewalls) (Note: Cut to Fit pans are not returnable.)

Item No	Description	Inlet	Retail
ALPAN1218C	12.00"-17.99" Aluminum Pan, Circular	1/2"	\$255
ALPAN1824C	18.01"-23.99" Aluminum Pan, Circular	1/2"	\$313
ALPAN2430C	24.01"-29.99" Aluminum Pan, Circular	1/2"	\$387
ALPAN3036C	30.01"-35.99" Aluminum Pan, Circular	1/2"	\$547
ALPAN3642C	36.01"-41.99" Aluminum Pan, Circular	3/4"	\$653
ALPAN4248C	42.01"-47.99" Aluminum Pan, Circular	3/4"	\$794
ALPAN4860C*	48.01"-59.99" Aluminum Pan, Circular	3/4"	\$1,166
ALPANCUST*	Custom Aluminum Pan (We can manufacture any custom shape or size.)		TBD

INSTALLATION COLLAR

Installation collars provide support for the aluminum plate, allowing for any size plate to be used for a range of sizes. This system will allow a 3" range added on to any plate size. (Example: a 30" plate can now fit up to a 33" opening)

Item No	Description	Retail
COLLAR	19" Universal Flexible Aluminum Installation Collar (order multiples depending on the size of the fire pit)	\$27



19" Collar

*Special Order

When ordering aluminum pans, please specify the exact size pan you would like for your project. Each pan is specifically cut for each order. Please allow 48 hours for shipping.

SQUARE PLATES

Select a Warming Trends Plate or Pan, Crossfire™ Burner and Ignition Kit (see pages 34-35) to make a complete burner system. Add your Media/Logs.

Warming Trends heavy duty aluminum mounting plates provide a solid ventilated/drainage surface to support your burner and your media choice. This plate is fitted with the proper gas supply connection point to attach the burner to the plate.

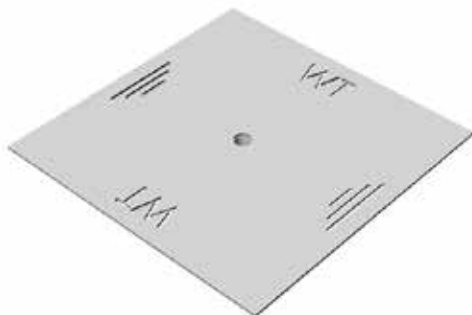

Square Plate

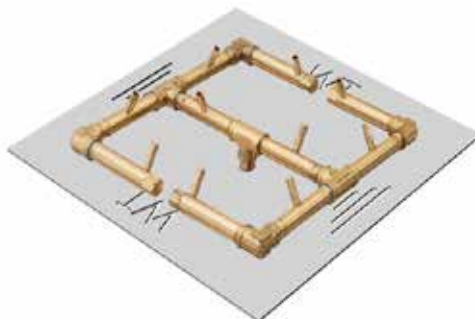

Square Plate shown with CFB120 Burner
Burner Sold Separately, See page 26-27

NOTE: It is recommended to incorporate 1 vent on at least two opposing sides (2 vents total) at a minimum size of 18 sq. inches each (Example: 3"x 6" or larger). Installation of the vents in the mid to lower area of the enclosure is recommended. Always consult with local municipality regarding any local code requirements. See page 34 for Vent Kit, item number FPVK.

SQUARE PLATES

Item No	Description	Inlet	Retail
ALPL18S	18" Aluminum Plate, Square	1/2"	\$98
ALPL24S	24" Aluminum Plate, Square	1/2"	\$188
ALPL30S	30" Aluminum Plate, Square	1/2"	\$252
ALPL36S	36" Aluminum Plate, Square	1/2"	\$379
ALPL42S	42" Aluminum Plate, Square	3/4"	\$506
ALPL48S	48" Aluminum Plate, Square	3/4"	\$651
ALPL60S*	60" Aluminum Plate, Square	3/4"	\$997

SQUARE PLATES - CUT TO FIT (Note: Cut to Fit plates are not returnable.)

Item No	Description	Inlet	Retail
ALPL1218S	12.00"-17.99" Aluminum Plate, Square	1/2"	\$147
ALPL1824S	18.01"-23.99" Aluminum Plate, Square	1/2"	\$240
ALPL2430S	24.01"-29.99" Aluminum Plate, Square	1/2"	\$307
ALPL3036S	30.01"-35.99" Aluminum Plate, Square	1/2"	\$463
ALPL3642S	36.01"-41.99" Aluminum Plate, Square	3/4"	\$555
ALPL4248S	42.01"-47.99" Aluminum Plate, Square	3/4"	\$699
ALPL4860S*	48.01"-59.99" Aluminum Plate, Square	3/4"	\$1,073
ALPLCUST*	Custom Aluminum Plate (We can manufacture any custom shape or size.)		TBD

INSTALLATION COLLAR

Installation collars provide support for the aluminum plate, allowing for any size plate to be used for a range of sizes. This system will allow a 3" range added on to any plate size. (Example: a 30" plate can now fit up to a 33" opening)

Item No	Description	Retail
COLLAR	19" Universal Flexible Aluminum Installation Collar (order multiples depending on the size of the fire pit)	\$27



19" Collar

*Special Order

When ordering aluminum plates, please specify the exact size plate you would like for your project. Each plate is specifically cut for each order. Please allow 48 hours for shipping.

SQUARE PANS

Select a Warming Trends Plate or Pan, Crossfire™ Burner and Ignition Kit (see pages 34-35) to make a complete burner system. Add your Media/Logs.

Using the Warming Trends heavy duty aluminum mounting pan with 2" sidewalls will provide a solid ventilated/drainage surface to support your burner and your media choice. This pan is fitted with the proper gas supply connection point to attach the burner to the pan.



Square Pan
with 2" Sidewall



Square Pan shown with CFB120 Burner
Burner Sold Separately, See page 26-27

NOTE: It is recommended to incorporate 1 vent on at least two opposing sides (2 vents total) at a minimum size of 18 sq. inches each (Example: 3"x 6" or larger). Installation of the vents in the mid to lower area of the enclosure is recommended. Always consult with local municipality regarding any local code requirements. See page 34 for Vent Kit, item number FPVK.

SQUARE PANS (with 2" Welded Sidewalls)

Item No	Description	Inlet	Retail
ALPAN18S	18" Aluminum Pan, Square	1/2"	\$218
ALPAN24S	24" Aluminum Pan, Square	1/2"	\$275
ALPAN30S	30" Aluminum Pan, Square	1/2"	\$347
ALPAN36S	36" Aluminum Pan, Square	1/2"	\$486
ALPAN42S	42" Aluminum Pan, Square	3/4"	\$609
ALPAN48S	48" Aluminum Pan, Square	3/4"	\$749
ALPAN60S*	60" Aluminum Pan, Square	3/4"	\$1,099

SQUARE PANS - CUT TO FIT (with 2" Welded Sidewalls) (Note: Cut to Fit pans are not returnable.)

Item No	Description	Inlet	Retail
ALPAN1218S	12.00"-17.99" Aluminum Pan, Square	1/2"	\$255
ALPAN1824S	18.01"-23.99" Aluminum Pan, Square	1/2"	\$313
ALPAN2430S	24.01"-29.99" Aluminum Pan, Square	1/2"	\$387
ALPAN3036S	30.01"-35.99" Aluminum Pan, Square	1/2"	\$547
ALPAN3642S	36.01"-41.99" Aluminum Pan, Square	3/4"	\$653
ALPAN4248S	42.01"-47.99" Aluminum Pan, Square	3/4"	\$794
ALPAN4860S*	48.01"-59.99" Aluminum Pan, Square	3/4"	\$1,166
ALPANCUST*	Custom Aluminum Pan (We can manufacture any custom shape or size.)		TBD

INSTALLATION COLLAR

Installation collars provide support for the aluminum plate, allowing for any size plate to be used for a range of sizes. This system will allow a 3" range added on to any plate size. (Example: a 30" plate can now fit up to a 33" opening)

Item No	Description	Retail
COLLAR	19" Universal Flexible Aluminum Installation Collar (order multiples depending on the size of the fire pit)	\$27



19" Collar

*Special Order

When ordering aluminum pans, please specify the exact size pan you would like for your project. Each pan is specifically cut for each order. Please allow 48 hours for shipping.

Select a Warming Trends Plate or Pan, Crossfire™ Burner and Ignition Kit (see pages 34-35) to make a complete burner system. Add your Media/Logs.

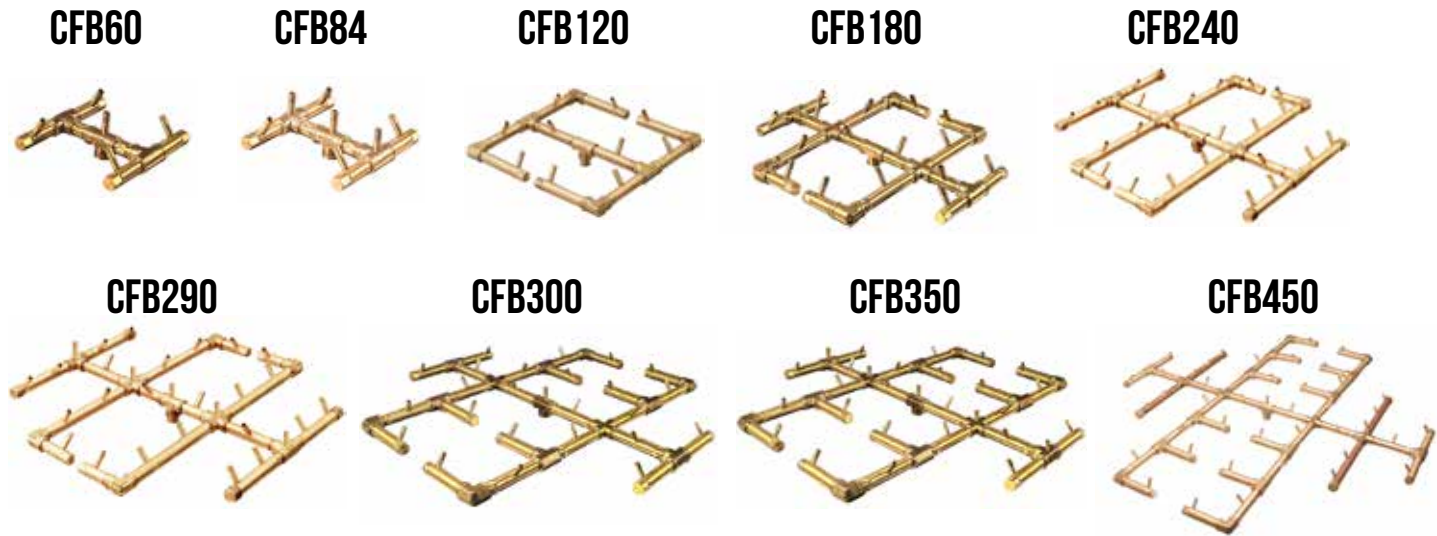

CROSSFIRE BURNERS

It is recommended that the burner be 4" from edge of Fire Pit, Fire Bowl or any Fire Feature.

Item No - NG	Item No - LP	Description	Top Elevation Dimensions	Corner Dimensions	Inlet	Retail
CFB60NG	CFB60LP	60,000 BTU Burner	7 1/2" L x 7 1/2" D	10 5/8"	1/2"	\$243
CFB84NG	CFB84LP	84,000 BTU Burner	7 1/2" L x 7 1/2" D	10 5/8"	1/2"	\$276
CFB120NG	CFB120LP	120,000 BTU Burner	13" L x 13" D	18"	1/2"	\$419
CFB180NG	CFB180LP	180,000 BTU Burner	17" L x 15" D	18 1/2"	1/2"	\$624
CFB240NG	CFB240LP	240,000 BTU Burner	21 1/2" L x 19 1/2" D	23 3/8"	1/2"	\$729
CFB290NG	CFB290LP	290,000 BTU Burner	21 1/2" L x 21 1/2" D	25 1/4"	1/2"	\$875
CFB300NG	CFB300LP	300,000 BTU Burner	30 1/2" L x 30 1/2" D	32 5/8"	3/4"	\$1,018
CFB350NG	CFB350LP	350,000 BTU Burner	30 1/2" L x 30 1/2" D	32 5/8"	3/4"	\$1,171
CFB450NG*	CFB450LP*	450,000 BTU Burner	46" L x 46" D	47 3/8"	3/4"	\$1,829
CFBCUSTNG*	CFBCUSTLP*	Custom BTU Burner - Custom Size and Shape				Call Empire

*Special Order

Add a 3412REDUCER when connecting burners with 1/2" inlet to plates and pans with 3/4" inlet.

Call Empire Distributing for quote on Custom Mounting Plate/Pan and Cover

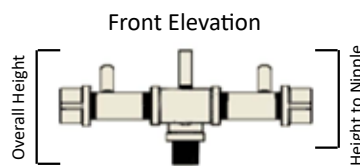
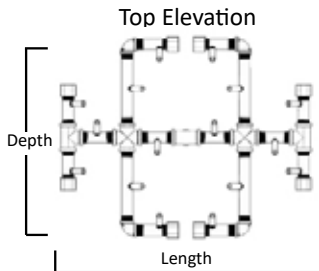

(Front Elevation Dimensions: Overall 3 5/8" H, 2 3/8" nipple)

1. For outdoor/external use only.
2. Modification of product will void any certification and warranty.
3. Follow all installation instructions and local codes.
4. Recommended to be installed by a certified plumbing professional.
5. All dimensions are true and reflect Warming Trends' specifications as of the revision date.

The Warming Trends® Patent-Pending CROSSFIRE® Brass Burner utilizes cutting-edge technology to produce a taller, brighter, full flame, replicating a natural, wood burning fire – all while consuming less gas. Made from corrosion resistant and sustainable brass, CROSSFIRE® Brass Burners will not rust and come with a lifetime warranty. All burners are manufactured and assembled in the United States.

OCTAGONAL CROSSFIRE BURNERS

Select a Warming Trends Plate or Pan, Crossfire™ Octagonal Style Burner and Ignition Kit (see pages 34-35) to make a complete burner system. Add your Media/Logs.

CFBO140



CFBO180



CFBO280

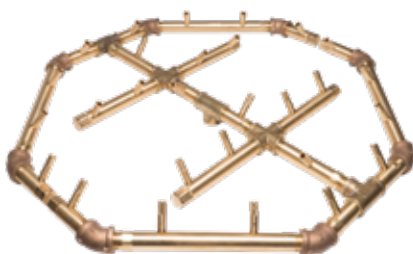

CFBO360



OCTAGONAL CROSSFIRE BURNERS

It is recommended that the burner be 4" from edge of Fire Pit, Fire Bowl or any Fire Feature.

Item No - NG	Item No - LP	Description	Dimensions	Inlet	Retail
CFBO140NG	CFBO140LP	140,000 BTU Octagonal Burner, NG	12.5" x 14.5"	1/2"	\$657
CFBO180NG	CFBO180LP	180,000 BTU Octagonal Burner, NG	14.75" x 15.75"	1/2"	\$885
CFBO280NG	CFBO280LP	280,000 BTU Octagonal Burner, NG	22.75" x 21.75"	3/4"	\$1,046
CFBO360NG	CFBO360LP	360,000 BTU Octagonal Burner, NG	29.5" x 27.5"	3/4"	\$1,549
CFBOCUSTNG*	CFBOCUSTLP*	Custom BTU Burner - Custom Size & Shape			Call Empire

*Special Order

Add a 3412REDUCER when connecting burners with 1/2" inlet to plates and pans with 3/4" inlet.

Call Empire Distributing for quote on Custom Mounting Plate/Pan and Cover

1. For outdoor/external use only.
2. Modification of product will void any certification and warranty.
3. Follow all installation instructions and local codes.
4. Recommended to be installed by a certified plumbing professional.
5. All dimensions are true and reflect Warming Trends' specifications as of the revision date.

The Warming Trends® Patent-Pending CROSSFIRE® Brass Burner utilizes cutting-edge technology to produce a taller, brighter, full flame, replicating a natural, wood burning fire – all while consuming less gas. Made from corrosion resistant and sustainable brass, CROSSFIRE® Brass Burners will not rust and come with a lifetime warranty. All burners are manufactured and assembled in the United States.

RECTANGLE PLATES

Select a Warming Trends Rectangle Plate or Pan, Crossfire™ Tree-Style, Double Tree, H-Style, or Linear Burner and Ignition Kit (see pages 34-35) to make a complete burner system. Add your Media/Logs.

Warming Trends heavy duty aluminum mounting plates provide a solid ventilated/drainage surface to support your burner and your media choice. This plate is fitted with the proper gas supply connection point to attach the burner to the plate.

NOTE: It is recommended to incorporate 1 vent on at least two opposing sides (2 vents total) at a minimum size of 18 sq. inches each (Example: 3"x 6" or larger). Installation of the vents in the mid to lower area of the enclosure is recommended. Always consult with local municipality regarding any local code requirements. See page 34 for Vent Kit, item number FPVK.



Rectangle Plate

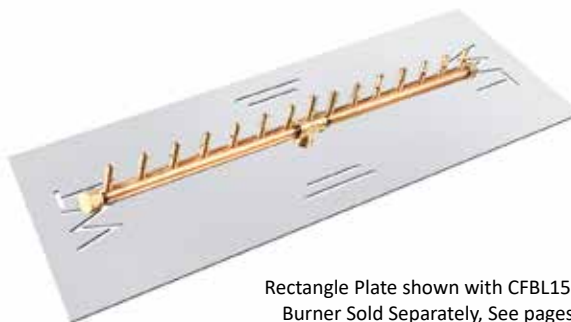

Rectangle Plate shown with CFBL150 Burner
Burner Sold Separately, See pages 30-33

RECTANGLE PLATES - CUT TO FIT (Note: Cut to Fit plates are not returnable.)

Item No	Description	Cut Range Length	Cut Range Width	Inlet	Retail
ALPL3618	Aluminum Rectangle Plate	24" - 36"	6" - 18"	1/2"	\$277
ALPL3624	Aluminum Rectangle Plate	24" - 36"	18" - 24"	1/2"	\$358
ALPL4818	Aluminum Rectangle Plate	36" - 48"	6" - 18"	1/2"	\$358
ALPL4824	Aluminum Rectangle Plate	36" - 48"	18" - 24"	1/2"	\$426
ALPL4832	Aluminum Rectangle Plate	36" - 48"	24" - 32"	3/4"	\$611
ALPL6018	Aluminum Rectangle Plate	48" - 60"	6" - 18"	3/4"	\$440
ALPL6024	Aluminum Rectangle Plate	48" - 60"	18" - 24"	3/4"	\$575
ALPL6032	Aluminum Rectangle Plate	48" - 60"	24" - 32"	3/4"	\$756
ALPLCUST	Custom Aluminum Plate (We can manufacture any custom shape or size.)				Call Empire

INSTALLATION COLLAR

Installation collars provide support for the aluminum plate, allowing for any size plate to be used for a range of sizes. This system will allow a 3" range added on to any plate size. (Example: a 30" plate can now fit up to a 33" opening)

Item No	Description	Retail
COLLAR	19" Universal Flexible Aluminum Installation Collar (order multiples depending on the size of the fire pit)	\$27



19" Collar

When ordering aluminum plates, please specify the exact size plate you would like for your project. Each plate is specifically cut for each order. Please allow 48 hours for shipping.

RECTANGLE PANS

Select a Warming Trends Rectangle Plate or Pan, Crossfire™ Tree-Style, Double Tree, H-Style, or Linear Burner and Ignition Kit (see pages 34-35) to make a complete burner system. Add your Media/Logs.

Using the Warming Trends heavy duty aluminum mounting pan with 2" sidewalls will provide a solid ventilated/drainage surface to support your burner and your media choice. This pan is fitted with the proper gas supply connection point to attach the burner to the pan.

NOTE: It is recommended to incorporate 1 vent on at least two opposing sides (2 vents total) at a minimum size of 18 sq. inches each (Example: 3"x 6" or larger). Installation of the vents in the mid to lower area of the enclosure is recommended. Always consult with local municipality regarding any local code requirements. See page 34 for Vent Kit, item number FPKV.



Rectangle Pan



Rectangle Pan shown with CFBH200 Burner
Burner Sold Separately, See page 30-33

RECTANGLE PANS - CUT TO FIT (with 2" Welded Sidewalls) (Note: Cut to Fit pans are not returnable.)

Item No	Description	Cut Range Length	Cut Range Width	Inlet	Retail
ALPAN3618	Aluminum Rectangle Pan	24" - 36"	6" - 18"	1/2"	\$416
ALPAN3624	Aluminum Rectangle Pan	24" - 36"	18" - 24"	1/2"	\$502
ALPAN4818	Aluminum Rectangle Pan	36" - 48"	6" - 18"	1/2"	\$506
ALPAN4824	Aluminum Rectangle Pan	36" - 48"	18" - 24"	1/2"	\$619
ALPAN4832	Aluminum Rectangle Pan	36" - 48"	24" - 32"	3/4"	\$770
ALPAN6018	Aluminum Rectangle Pan	48" - 60"	6" - 18"	3/4"	\$596
ALPAN6024	Aluminum Rectangle Pan	48" - 60"	18" - 24"	3/4"	\$737
ALPAN6032	Aluminum Rectangle Pan	48" - 60"	24" - 32"	3/4"	\$924
ALPANCUST	Custom Aluminum Pan (We can manufacture any custom shape or size.)				Call Empire

INSTALLATION COLLAR

Installation collars provide support for the aluminum plate, allowing for any size plate to be used for a range of sizes. This system will allow a 3" range added on to any plate size. (Example: a 30" plate can now fit up to a 33" opening)

Item No	Description	Retail
COLLAR	19" Universal Flexible Aluminum Installation Collar (order multiples depending on the size of the fire pit)	\$27



19" Collar

When ordering aluminum pans, please specify the exact size pan you would like for your project. Each pan is specifically cut for each order. Please allow 48 hours for shipping.

TREE-STYLE CROSSFIRE BURNERS

Select a Warming Trends Rectangle Plate or Pan, Crossfire™ Tree-Style Burner and Ignition Kit (see pages 34-35) to make a complete burner system. Add your Media/Logs.

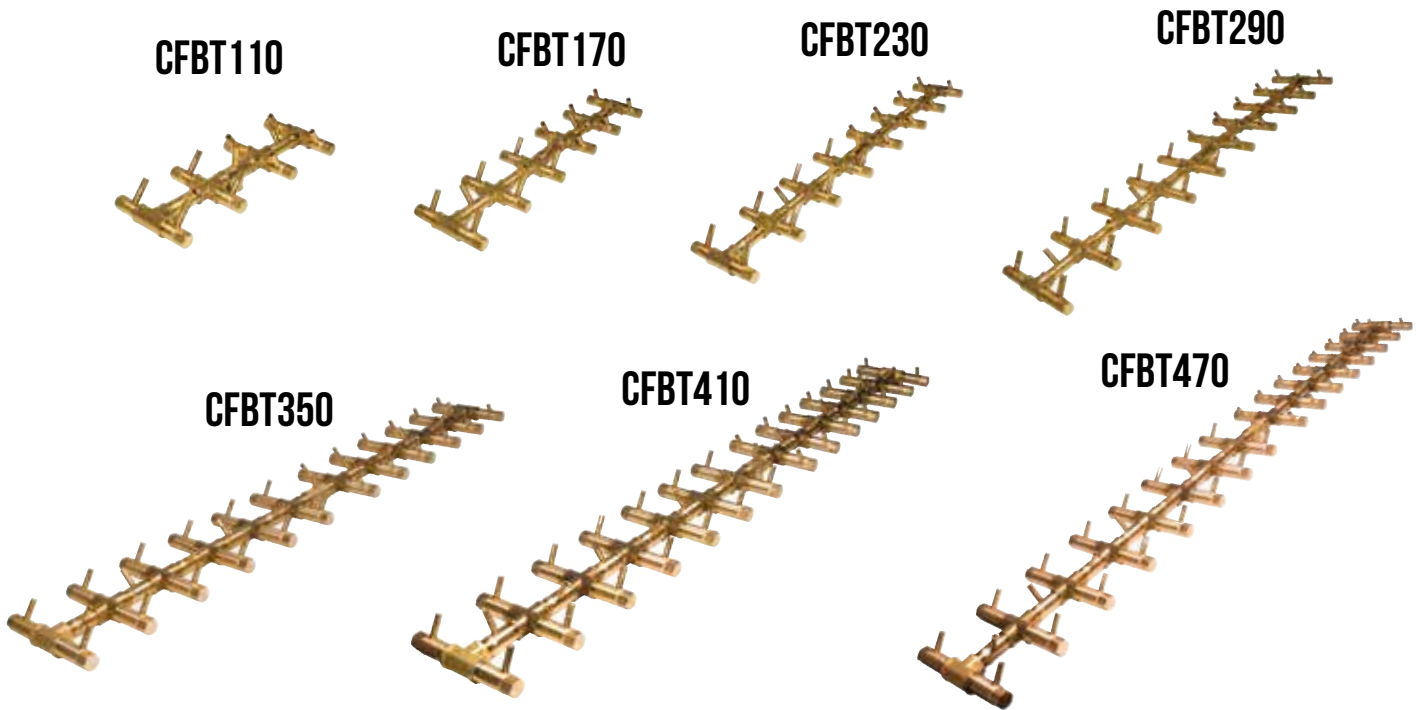

TREE-STYLE CROSSFIRE BURNERS

It is recommended that the burner be 4" from edge of Fire Pit, Fire Bowl or any Fire Feature.

Item No - NG	Item No - LP	Description	Dimensions	Inlet	Retail
CFBT110NG	CFBT110LP	110,000 BTU Tree-Style Burner	5.25" x 13.75"	1/2"	\$484
CFBT170NG	CFBT170LP	170,000 BTU Tree-Style Burner	5.25" x 22"	1/2"	\$758
CFBT230NG	CFBT230LP	230,000 BTU Tree-Style Burner	7.25" x 30"	1/2"	\$941
CFBT290NG	CFBT290LP	290,000 BTU Tree-Style Burner	7.25" x 38"	1/2"	\$1,128
CFBT350NG	CFBT350LP	350,000 BTU Tree-Style Burner	7.50" x 51.5"	3/4"	\$1,570
CFBT410NG	CFBT410LP	410,000 BTU Tree-Style Burner	7.50" x 60"	3/4"	\$1,838
CFBT470NG	CFBT470LP	470,000 BTU Tree-Style Burner	7.50" x 67.75"	3/4"	\$2,071
CFBTCUSTNG*	CFBTCUSTLP*	Custom BTU Tree-Style Burner - Custom Size and Shape			Call Empire

*Special Order Add a 3412REDUCER when connecting burners with 1/2" inlet to plates and pans with 3/4" inlet.

Call Empire Distributing for quote on Custom Mounting Plate/Pan and Cover

1. For outdoor/external use only.
2. Modification of product will void any certification and warranty.
3. Follow all installation instructions and local codes.
4. Recommended to be installed by a certified plumbing professional.
5. All dimensions are true and reflect Warming Trends' specifications as of the revision date.

The Warming Trends® Patent-Pending CROSSFIRE® Brass Burner utilizes cutting-edge technology to produce a taller, brighter, full flame, replicating a natural, wood burning fire – all while consuming less gas. Made from corrosion resistant and sustainable brass, CROSSFIRE® Brass Burners will not rust and come with a lifetime warranty. All burners are manufactured and assembled in the United States.

DOUBLE TREE CROSSFIRE BURNERS

Select a Warming Trends Rectangle Plate or Pan, Crossfire™ Double Tree Style Burner and Ignition Kit (see pages 34-35) to make a complete burner system. Add your Media/Logs.

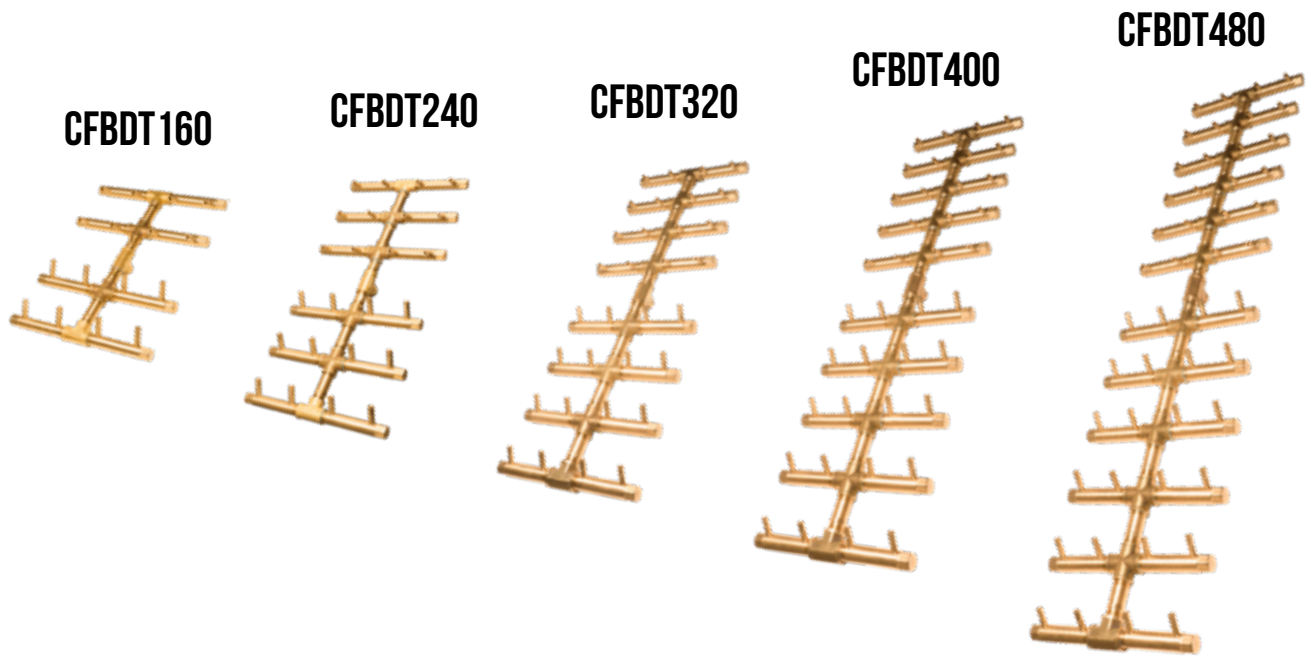

DOUBLE TREE CROSSFIRE BURNERS

It is recommended that the burner be 4" from edge of Fire Pit, Fire Bowl or any Fire Feature.

Item No - NG	Item No - LP	Description	Dimensions	Inlet	Retail
CFBDT160NG	CFBDT160LP	160,000 BTU Double Tree-Style Burner	11.25" x 15.75"	1/2"	\$669
CFBDT240NG	CFBDT240LP	240,000 BTU Double Tree-Style Burner	11.25" x 23.25"	1/2"	\$1,012
CFBDT320NG	CFBDT320LP	320,000 BTU Double Tree-Style Burner	11.50" x 35.25"	3/4"	\$1,519
CFBDT400NG	CFBDT400LP	400,000 BTU Double Tree-Style Burner	11.50" x 44.25"	3/4"	\$1,902
CFBDT480NG	CFBDT480LP	480,000 BTU Double Tree-Style Burner	11.50" x 53"	3/4"	\$2,283
CFBDTCUSTNG*	CFBDTCUSTLP*	Custom BTU Double Tree-Style Burner - Custom Size and Shape			Call Empire

*Special Order Add a 3412REDUCER when connecting burners with 1/2" inlet to plates and pans with 3/4" inlet.

Call Empire Distributing for quote on Custom Mounting Plate/Pan and Cover

1. For outdoor/interior use only.
2. Modification of product will void any certification and warranty.
3. Follow all installation instructions and local codes.
4. Recommended to be installed by a certified plumbing professional.
5. All dimensions are true and reflect Warming Trends' specifications as of the revision date.

The Warming Trends® Patent-Pending CROSSFIRE® Brass Burner utilizes cutting-edge technology to produce a taller, brighter, full flame, replicating a natural, wood burning fire – all while consuming less gas. Made from corrosion resistant and sustainable brass, CROSSFIRE® Brass Burners will not rust and come with a lifetime warranty. All burners are manufactured and assembled in the United States.

H-STYLE CROSSFIRE BURNERS

WARMING  TRENDS



Select a Warming Trends Rectangle Plate or Pan, Crossfire™ H-Style Burner and Ignition Kit (see pages 34-35) to make a complete burner system. Add your Media/Logs.

CFBH120



CFBH160



CFBH200



CFBH240



CFBH300



CFBH340



H-SYTL E CROSSFIRE BURNERS

It is recommended that the burner be 4" from edge of Fire Pit, Fire Bowl or any Fire Feature.

Item No - NG	Item No - LP	Description	Dimensions	Inlet	Retail
CFBH120NG	CFBH120LP	120,000 BTU H-Style Burner	7" x 18"	1/2"	\$571
CFBH160NG	CFBH160LP	160,000 BTU H-Style Burner	9" x 24"	1/2"	\$679
CFBH200NG	CFBH200LP	200,000 BTU H-Style Burner	9" x 30"	1/2"	\$778
CFBH240NG	CFBH240LP	240,000 BTU H-Style Burner	9" x 36"	1/2"	\$894
CFBH300NG	CFBH300LP	300,000 BTU H-Style Burner	14" x 42"	3/4"	\$1,157
CFBH340NG	CFBH340LP	340,000 BTU H-Style Burner	14" x 48"	3/4"	\$1,295
CFBHCUSTNG*	CFBHCUSTLP*	CUSTOM H-Style Burner			Call Empire

*Special Order Add a 3412REDUCER when connecting burners with 1/2" inlet to plates and pans with 3/4" inlet.

Call Empire Distributing for quote on Custom Mounting Plate/Pan and Cover

1. For outdoor/interior use only.
2. Modification of product will void any certification and warranty.
3. Follow all installation instructions and local codes.
4. Recommended to be installed by a certified plumbing professional.
5. All dimensions are true and reflect Warming Trends' specifications as of the revision date.

The Warming Trends® Patent-Pending CROSSFIRE® Brass Burner utilizes cutting-edge technology to produce a taller, brighter, full flame, replicating a natural, wood burning fire – all while consuming less gas. Made from corrosion resistant and sustainable brass, CROSSFIRE® Brass Burners will not rust and come with a lifetime warranty. All burners are manufactured and assembled in the United States.

LINEAR CROSSFIRE BURNERS



Select a Warming Trends Rectangle Plate or Pan, Crossfire™ Linear Burner and Ignition Kit (see pages 34-35) to make a complete burner system. Add your Media/Logs.

CFBL90



CFBL110



CFBL130



CFBL150



CFBL190

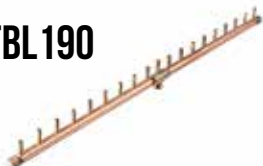

CFBL210



CFBL250



CFBL270



LINEAR CROSSFIRE BURNERS

It is recommended that the burner be 4" from edge of Fire Pit, Fire Bowl or any Fire Feature.

Item No - NG	Item No - LP	Description	Length	Inlet	Retail
CFBL90NG	CFBL90LP	90,000 BTU Linear Burner	18"	1/2"	\$310
CFBL110NG	CFBL110LP	110,000 BTU Linear Burner	22"	1/2"	\$395
CFBL130NG	CFBL130LP	130,000 BTU Linear Burner	26"	1/2"	\$461
CFBL150NG	CFBL150LP	150,000 BTU Linear Burner	30"	1/2"	\$511
CFBL190NG	CFBL190LP	190,000 BTU Linear Burner	38"	1/2"	\$592
CFBL210NG	CFBL210LP	210,000 BTU Linear Burner	42"	1/2"	\$658
CFBL250NG	CFBL250LP	250,000 BTU Linear Burner	50"	1/2"	\$738
CFBL270NG	CFBL270LP	270,000 BTU Linear Burner	54"	1/2"	\$826
CFBLCUSTNG*	CFBLCUSTLP*	CUSTOM Linear Burner, NG			Call Empire

*Special Order Add a 3412REDUCER when connecting burners with 1/2" inlet to plates and pans with 3/4" inlet.

Call Empire Distributing for quote on Custom Mounting Plate/Pan and Cover

1. For outdoor/interior use only.
2. Modification of product will void any certification and warranty.
3. Follow all installation instructions and local codes.
4. Recommended to be installed by a certified plumbing professional.
5. All dimensions are true and reflect Warming Trends' specifications as of the revision date.

The Warming Trends® Patent-Pending CROSSFIRE® Brass Burner utilizes cutting-edge technology to produce a taller, brighter, full flame, replicating a natural, wood burning fire – all while consuming less gas. Made from corrosion resistant and sustainable brass, CROSSFIRE® Brass Burners will not rust and come with a lifetime warranty. All burners are manufactured and assembled in the United States.

IGNITION KITS

Match Light & Push Button

MATCH LIGHT

Item No	Description	BTU's	Retail
FLKV12	Key Valve Kit (Includes: 36" L x 1/2" Diameter Whistle Free Flex Line; 1/2" Connector; 1/2" Key Valve; 12" & 3" Key)	up to 120,000	\$91
FLKV34-12	Key Valve Kit (Includes: 36" L x 3/4" Diameter Whistle Free Flex Line; 3/4" Connector; 3/4" Key Valve; 12" & 3" Key)	121,000 - 249,000	\$170
DFLKV34-U	Key Valve Kit (Includes: (2) 36" L x 3/4" Whistle Free Flex Lines, 3/4"-1/2" Reducing Nipple, (2) 3/4" T Fittings, (2) 3" L x 3/4" Pipe Nipple, 3/4" Key Valve, and 12" & 3" Key)	250,000+	\$360
3412REDUCER	Reducer 3/4" to 1/2" (For use connecting burners with 1/2" inlet to plates and pans with 3/4" inlet) (Comes standard in the DFLKV34-U Kit)		\$10
FP.EXT	12" Adjustable Key Valve Extension with 1/2" Banded Coupling		\$15



Match Light Key Valve Kit
FLKV34-12



Match Light Key Valve Kit
DFLKV34-U



Reducer
3412REDUCER



Adjustable Key Valve Extension
FP.EXT

PUSH BUTTON

Item No	Description	BTU's	Retail
PBFLKV12	Push Button Ignition Kit - Includes: Paver Block Mounting Bracket, & FLKV12	up to 120,000	\$280
PBFLKV34-12	Push Button Ignition Kit - Includes: Paver Block Mounting Bracket, & FLKV34-12	121,000 - 249,000	\$358
PBDFLKV34-U	Push Button Ignition Kit - Includes: Paver Block Mounting Bracket, & DFLKV34-U	250,000+	\$548
PBIK	Push Button Ignition Kit (Spark Igniter rod, wire, and Push Button Operated Control Module)		\$52
PBIK-PBMBR	Push Button Ignition Kit w/ Paver Block Mounting Bracket (for easy mounting of your PBIK into your paver kit)		\$136
3412REDUCER	Reducer 3/4" to 1/2" (For use connecting burners with 1/2" inlet to plates and pans with 3/4" inlet) (Comes standard in the DFLKV34-U Kit)		\$10



Push Button Ignition
w/ Key Valve Kit



Reducer
3412REDUCER

ACCESSORIES

Item No	Description	Retail
DRIP12	1/2" Drip Leg Kit, fits any plate and pan with 1/2" inlet	\$51
DRIP34	3/4" Drip Leg Kit, fits any plate and pan with 3/4" inlet	\$69
NKY.8.BR	8" Gas Valve Key, Brass	\$10
NKY.8.CR	8" Gas Valve Key, Chrome	\$10
NKY.12.BR	12" Gas Valve Key, Brass	\$14
NKY.12.CR	12" Gas Valve Key, Chrome	\$14
NKY.18.BR	18" Gas Valve Key, Brass	\$19
NKY.18.CR	18" Gas Valve Key, Chrome	\$19
NKY.24.BR	24" Gas Valve Key, Brass	\$26
NKY.24.CR	24" Gas Valve Key, Chrome	\$26
FPVK	Fire Pit Vent Kit (Set of 2) (3 3/4" x 12", includes hardware)	\$51



Drip Leg Kit
DRIP12



Gas Valve Keys

Additional Accessories on next page. For additional key sizes, please see page 88 in the Outdoor Fireplace section.

IGNITION KITS

24V Electronic

ELECTRONIC IGNITION KITS *(Requires Key Valve Kit to complete)*

All Electronic Ignition Kits must be factory installed and fire pits must be covered to fulfill warranty requirements. 24V Electronic Ignition Kits are water resistant. Does NOT include wall switch and remote.

Item No - NG	Item No - NG	Description	Capacity	Max BTU's	Retail
P24VIK-SCCG-NG*	P24VIK-SCCG-LP*	Electronic Ignition Kit	Standard	290,000	\$1,845
P24VIK-HCCG-NG*	P24VIK-HCCG-LP*	Electronic Ignition Kit	High	512,000	\$1,995



P24VIK



Match Light Key Valve Kit
FLKV34-12



Match Light Key Valve Kit
DFLKV34-U



Reducer
3412REDUCER



Adjustable Key Valve Extension
FP.EXT

KEY VALVE KITS *(Required with purchase of 24V Electronic Ignition System)*

Item No	Description	BTU's	Retail
FLKV12	Key Valve Kit (Includes: 36" L x 1/2" Diameter Whistle Free Flex Line; 1/2" Connector; 1/2" Key Valve; 12" & 3" Key)	up to 120,000	\$91
FLKV34-12	Key Valve Kit (Includes: 36" L x 3/4" Diameter Whistle Free Flex Line; 3/4" Connector; 3/4" Key Valve; 12" & 3" Key)	121,000 - 249,000	\$170
DFLKV34-U	Key Valve Kit (Includes: (2) 36" L x 3/4" Whistle Free Flex Lines, 3/4"-1/2" Reducing Nipple, (2) 3/4" T Fittings, (2) 3" L x 3/4" Pipe Nipple, 3/4" Key Valve, and 12" & 3" Key)	250,000+	\$360
3412REDUCER	Reducer 3/4" to 1/2" (For use connecting burners with 1/2" inlet to plates and pans with 3/4" inlet) (Comes standard in the DFLKV34-U Kit)		\$10
FP.EXT	12" Adjustable Key Valve Extension with 1/2" Banded Coupling		\$15

ELECTRONIC ACCESSORIES

Item No	Description	Retail
KCRC	Wireless Key Chain Remote Control & Plug In Receiver - Universal	\$42
EMERSTOP	Emergency Stopper Station (Yellow Shell, Mini Weather Stopper Lift Cover w/ Spacer, Turn to Reset Illuminated Red Octagon PUSH button)	\$313
DT12HRNB	12 Hour Dial Timer - Mounted in NEMA 3 Rated Enclosure	\$419
DT2HRNB	2 Hour Dial Timer - Mounted in NEMA 3 Rated Enclosure	\$403

ACCESSORIES

Item No	Description	Retail
LPRH	LP Regulator with a 3/8" 10' Hose (Will only allow flow for up to 124K BTU's. For use with a 20 lb LP tank)	\$161
FL3612	36" L x 1/2" Diameter Whistle Free Flex Line; 1/2" Connector	\$69
FL3634	36" L x 3/4" Diameter Whistle Free Flex Line; 3/4" Connector	\$116
BVS2	3/4" - 1/4 Turn Ball Valve - Straight	\$32
FPVK	Fire Pit Vent Kit - Set of 2 (3 3/4" x 12", includes hardware)	\$51
VENTBLOCK-BLK	Vent 4" x 6" Rectangular (1 Vent)	\$25



Emergency Stop
EMERSTOP



Digital Timer
DT12HRNB



LP Regulator with Hose
LPRH



Whistle Free Flex Line
FL3612



Gas Ball Valve,
Straight



Fire Pit Vent Kit
(Set of 2)

LAVA ROCKS & LOG SETS

LAVA ROCK & STONE

See Media Calculator on page 44.

Item No	Description	Rock/Stone Size	Bag Size	Manufacturer	Retail
BLR	Lava Rock, Black	1" - 1 1/2"	40 lb	Warming Trends	\$45
LAVA-XXL-20	Lava Rock, XXL	4" - 6"	20 lb	Exotic Pebbles	\$59
NL-3050	Tumbled Lava Stone, Medium	1" - 2"	50 lb	Exotic Pebbles	\$105
NL-5080	Tumbled Lava Stone, Large	2" - 3"	50 lb	Exotic Pebbles	\$105
NL-7090	Tumbled Lava Stone, XXL	3" - 5"	50 lb	Exotic Pebbles	\$105



BLR
1" - 1 1/2"



LAVA-XXL
4" - 6"



NL-3050
1" - 2"



NL-5080
2" - 3"



NL-7090
3" - 5"

REFRACTORY LOG SETS



Outdoor fire pit log sets are for use with common ring type burners.

Item No	Description	Pieces	Fire Pit Inside Dimensions	Retail
WCS2006FL	20" Wilderness Char	6	18" - 24"	\$220
WCS3010FL	30" Wilderness Char	10	24" - 40"	\$645
WCS5019FL	50" Wilderness Char	19	40" - 60"	\$1,244
WOS3008FL	30" Wilderness Oak	8	24" - 40"	\$416
WOS5014FL	50" Wilderness Oak	14	40" - 60"	\$812



Wilderness Char Fire Pit Log Set



Wilderness Oak Fire Pit Log Set

FIREGLASS



REFLECTIVE FIREGLASS $\frac{1}{2}$ " Crushed

Item No	Description	Tub Size	Retail
EFG-R03M	Black Reflective	12 lb	\$67
EG25-R03MP	Black Reflective	25 lb	\$130
EFG-R05M	Bronze Reflective	12 lb	\$67
EG25-R05MP	Bronze Reflective	25 lb	\$130
EFG-R02M	Cobalt Blue Reflective	12 lb	\$67
EG25-R02MP	Cobalt Blue Reflective	25 lb	\$130
EFG-R01M	Copper Reflective	12 lb	\$67
EG25-R01MP	Copper Reflective	25 lb	\$130
EFG-R06M	Gold Reflective	12 lb	\$72
EG25-R06MP	Gold Reflective	25 lb	\$139
EFG-R04M	Sky Blue Reflective	12 lb	\$67
EG25-R04MP	Sky Blue Reflective	25 lb	\$130
EFG-R09M	Silver Reflective	12 lb	\$67
EG25-R09MP	Silver Reflective	25 lb	\$130
EFG-R12M	Tahiti Teal Reflective	12 lb	\$67
EG25-R12MP	Tahiti Teal Reflective	25 lb	\$130

See Media Calculator on page 44.

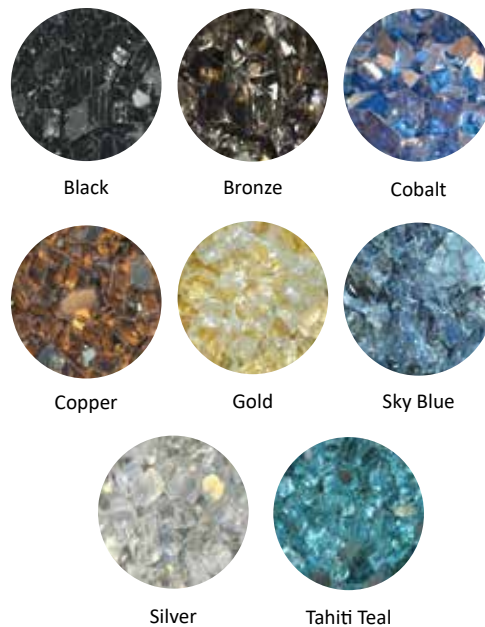

CLASSIC FIREGLASS $\frac{1}{2}$ " - $\frac{3}{4}$ " Crushed

Item No	Description	Tub Size	Retail
EFG-C12M	Amber Classic	12lb	\$67
EG25-L12MP	Amber Classic	25 lb	\$130
EFG-C02M	Black Classic	12 lb	\$67
EG25-L02MP	Black Classic	25 lb	\$130
EFG-C13M	Cobalt Blue Classic	12 lb	\$67
EG25-L13MP	Cobalt Blue Classic	25 lb	\$130
EFG-C01M	Ice Clear Classic	12 lb	\$67
EG25-L01MP	Ice Clear Classic	25 lb	\$130
EFG-C05M	Ocean Blue Classic	12 lb	\$67
EG25-L05MP	Ocean Blue Classic	25 lb	\$130
EFG-C04M	Turquoise Classic	12 lb	\$67
EG25-L04MP	Turquoise Classic	25 lb	\$130



ZIRCON Luster

Item No	Description	Tub Size	Retail
ZIR-BLKDMDLST	Black Diamond Luster	10 lb	\$51
ZIR-MIDBLLST	Midnight Blue Luster	10 lb	\$51
ZIR-PWDBLLST	Powder Blue Luster	10 lb	\$51
ZIR-RNDRPLST	Rain Drop Luster	10 lb	\$51





We recommend you add a cover to any fire feature to prevent water build up in your gas lines. Water build up could cause issues in your fire pit performance. A cover is required with any Warming Trends system utilizing a 24V electronic ignition system. All covers are Aluminum which will not rust or tarnish.

CIRCULAR COVERS

Item No	Description	Fits Opening Size	Handles	Retail
FPC20C	20" Aluminum Cover, Circular	18"	1	\$249
FPC26C	26" Aluminum Cover, Circular	24"	1	\$353
FPC32C	32" Aluminum Cover, Circular	30"	1	\$484
FPC38C	38" Aluminum Cover, Circular	36"	2	\$642
FPC44C	44" Aluminum Cover, Circular	42"	2	\$828
FPC50C	50" Aluminum Cover, Circular	48"	2	\$1,040



CIRCULAR COVER
1 handle

SQUARE COVERS

Use the Burner Pit Cover to protect your fire pit from the elements, give it that finished look, and keep unwanted debris out of the fire pit.

Item No	Description	Fits Opening Size	Handles	Retail
FPC20S	20" Aluminum Cover, Square	18"	1	\$249
FPC26S	26" Aluminum Cover, Square	24"	1	\$353
FPC32S	32" Aluminum Cover, Square	30"	1	\$484
FPC38S	38" Aluminum Cover, Square	36"	2	\$642
FPC44S	44" Aluminum Cover, Square	42"	2	\$828
FPC50S	50" Aluminum Cover, Square	48"	2	\$1,040



SQUARE COVER
2 handles (Shown)

CUSTOM COVERS

Available in any shape or size your project requires. All custom covers will ship FOB direct from the manufacturer.

Item No	Description	Retail
FPCUST*	Custom Cover, Aluminum	Call for Pricing

*Special Order



CUSTOM COVER
2 handles (Shown)

FIRE PIT COVERS



We recommend you add a cover to any fire feature to prevent water build up in your gas lines. Water build up could cause issues in your fire pit performance. A cover is required with any Warming Trends system utilizing a 24V electronic ignition system. All covers are 1/8" thick Aluminum and Powder Coated Charcoal Gray with a UV protected paint.

CIRCULAR COVERS

Item No	Description	Thickness	Handles	Retail
SC26C-CG	26" Powder Coated Cover, Circular	1/8"	2	\$244
SC32C-CG	32" Powder Coated Cover, Circular	1/8"	2	\$321
SC38C-CG	38" Powder Coated Cover, Circular	1/8"	2	\$462
SC44C-CG	44" Powder Coated Cover, Circular	1/8"	2	\$618
SC50C-CG*	50" Powder Coated Cover, Circular (2 piece)	1/8"	2	\$795



Circular Cover
1 piece



50" Circular Cover
2 piece

SQUARE COVERS

Item No	Description	Thickness	Handles	Retail
SC26S-CG	26" Powder Coated Cover, Square	1/8"	2	\$244
SC32S-CG	32" Powder Coated Cover, Square	1/8"	2	\$321
SC38S-CG	38" Powder Coated Cover, Square	1/8"	2	\$462
SC44S-CG	44" Powder Coated Cover, Square	1/8"	2	\$618
SC50S-CG*	50" Powder Coated Cover, Square (2 piece)	1/8"	2	\$795



Square Cover
1 piece

CUSTOM COVERS

Available in any shape or size your project requires. All custom covers will ship FOB direct from the manufacturer. There is a minimum custom cover charge of \$280 Retail.

Item No	Description	Retail
SC-CUST-TB*	Fire Pit Custom Cover, Textured Bronze	Call for Pricing
SC-CUST-CG*	Fire Pit Custom Cover, Charcoal Gray	



Rectangle Custom Cover
2 handle

*Special Order

Note: Optional skirts available. Call for Pricing.

29 1/4" BURNER SYSTEM



These Warming Trends kits come with everything you need to complete a basic installation of a gas burner in a 30" (inside diameter) fire pit. These kits also feature a discounted bundled price. A customer may add any number of accessories to complete their project including media, logs, and burner cover.

- FOR USE WITH:**
- Valencia, Techo-Bloc
 - Countryside, Belgard
 - Flagstone, Belgard
 - Serafina, Nicolock
 - 30" Round, Genest

29 1/4" BURNER SYSTEM

Item No - NG	Item No - LP	Description	Retail
VAL-ML-180NG	VAL-ML-180LP	Burner System w/ Match Light Ignition, 180K Includes: 180,000 BTU Burner, 29 1/4" Plate, and FLKV34-12 Match Light Key Valve Kit	\$1,046
VAL-PBI-180NG	VAL-PBI-180LP	Burner System w/ Push Button Ignition, 180K Includes: 180,000 BTU Burner, 29 1/4" Plate, and PBFLKV34-12 Push Button Ignition Kit	\$1,098
VAL-EI-180NG	VAL-EI-180LP	Burner System w/ Electronic Ignition, 180K Includes: 180,000 Burner, 29 1/4" Plate, and P24VIK-SCCG Premium Electronic Ignition System & FLKV34-12 Key Valve Kit. Requires Burner Cover - see page 38-39	\$3,199

INSTALLATION COLLAR

Installation collars provide support for the aluminum plate, allowing for any size plate to be used for a range of sizes. This system will allow a 3" range added on to any plate size. (Example: a 30" plate can now fit up to a 33" opening)

Item No	Description	Retail
COLLAR	19" Universal Flexible Aluminum Installation Collar (order multiples depending on the size of the fire pit)	\$27



19" Collar

ACCESSORIES

Item No	Description	Retail
FP.EXT	12" Adjustable Key Valve Extension with 1/2" Banded Coupling	\$15
FPVK	Fire Pit Vent Kit - Set of 2 (3 3/4" x 12", includes hardware)	\$51

All Electronic Ignition Accessories are found on pages 34-35.



180,000 BTU Burner and Plate



Match Light Key Valve Kit



Push Button Ignition Kit



Electronic Ignition System

WIND GUARDS



Fire Pit Flame Guards provide an additional safety barrier, help maintain a central flame during the evening breeze, all while providing an enhanced fire elegance by reflecting the flames on the glass surfaces. Made from tempered glass, all our Fire Pit Flame Guards are heat resistant with polished edges, and designed for use with any fire pit.

LINEAR

Item No	Description	Inside Assembled Dimension (LxWxH)	Retail
FG-LCB-30	Linear Glass Wind Guard	35.5" x 11.5" x 6"	\$179
FG-LCB-36	Linear Glass Wind Guard	41.5" x 11.5" x 6"	\$189
FG-LCB-48	Linear Glass Wind Guard	53.5" x 11.5" x 6"	\$199
FG-LCB-60	Linear Glass Wind Guard	65.5" x 11.5" x 6"	\$219
FG-LCB-72	Linear Glass Wind Guard	77.5" x 11.5" x 6"	\$309

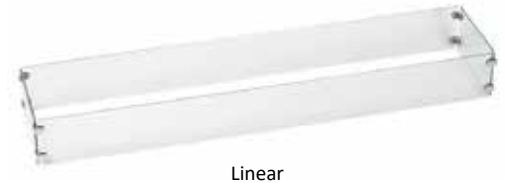

RECTANGLE

Item No	Description	Inside Assembled Dimension (LxWxH)	Retail
FG-AFPP-18*	Rectangular Glass Wind Guard	23.5" x 11.5" x 6"	\$179
FG-AFPP-24	Rectangular Glass Wind Guard	29.5" x 13.5" x 6"	\$189
FG-AFPP-30	Rectangular Glass Wind Guard	35.5" x 15.5" x 6"	\$199
FG-AFPP-36	Rectangular Glass Wind Guard	41.5" x 17.5" x 6"	\$219
FG-AFPP-48	Rectangular Glass Wind Guard	53.5" x 19.5" x 6"	\$229

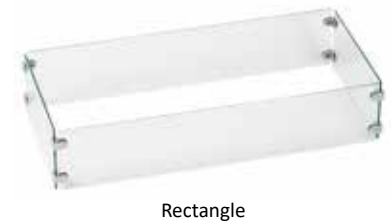

SQUARE

Item No	Description	Inside Assembled Dimension (LxWxH)	Retail
FG-SQP-12*	Square Glass Wind Guard	17.5" x 17.5" x 6"	\$169
FG-SQP-18*	Square Glass Wind Guard	23.5" x 23.5" x 6"	\$179
FG-SQP-24	Square Glass Wind Guard	29.5" x 29.5" x 6"	\$189
FG-SQP-30	Square Glass Wind Guard	35.5" x 35.5" x 6"	\$199
FG-SQP-36	Square Glass Wind Guard	41.5" x 41.5" x 6"	\$219



ROUND

Item No	Description	Inside Assembled Dimension (WxH)	Retail
FG-RSP-19	Round Glass Wind Guard	23" x 8"	\$299
FG-RSP-25	Round Glass Wind Guard	29" x 8"	\$399



WIND GUARD CLIPS

(For use with 1/8" glass. Glass not included)

Item No	Description	Retail
GC-90KIT	Wind Guard Clips (Includes: 8 clips to complete square or rectangle wind guard 36" or smaller per side. Glass not included)	\$33
GCS-90KIT	Wind Guard Clips (Includes: 12 clips to complete square or rectangle wind guard 37" or longer per side. Glass not included)	\$39



*Special Order

Custom sized Wind Guards available. Call Empire for details.

BUILD YOUR OWN FIRE PIT KIT



ROUND DROP-IN PANS WITH FIRE RING BURNER

Item No	Description	Retail
SS-RSP-19-ASBL*	19" Round SS Drop-In Fire Pit Pan w/ 12" Ring Burner (1/2" Nipple)	\$500
SS-RSP-25-ASBL	25" Round SS Drop-In Fire Pit Pan w/ 18" Ring Burner (1/2" Nipple)	\$605



Round Drop-In Pan and Fire Ring Burner

ROUND FLAT PANS WITH FIRE RING BURNER

Item No	Description	Retail
SS-RFP-18-ASBL	18" Round Stainless Steel Flat Pan w/ 12" Ring Burner (1/2" Nipple)	\$300
SS-RFP-24-ASBL	24" Round Stainless Steel Flat Pan w/ 18" Ring Burner (1/2" Nipple)	\$375
SS-RFP-30-ASBL	30" Round Stainless Steel Flat Pan w/ 18" Ring Burner (1/2" Nipple)	\$489
SS-RFP-36-ASBL	36" Round Stainless Steel Flat Pan w/ 18" Ring Burner (1/2" Nipple)	\$583



Round Flat Pan and Fire Ring Burner

SQUARE DROP-IN PANS WITH FIRE RING BURNER

Item No	Description	Retail
SS-SQP-18-ASBL*	18" Square SS Drop-In Fire Pit Pan w/ 12" Ring Burner (1/2" Nipple)	\$406
SS-SQP-24-ASBL*	24" Square SS Drop-In Fire Pit Pan w/ 18" Ring Burner (1/2" Nipple)	\$521
SS-SQP-30-ASBL*	30" Square SS Drop-In Fire Pit Pan w/ 18" Ring Burner (1/2" Nipple)	\$618
SS-SQP-36-ASBL*	36" Square SS Drop-In Fire Pit Pan w/ 18" Ring Burner (1/2" Nipple)	\$718



Square Drop-In Pan and Fire Ring Burner

Select a Fire Pit Ring, Pan, Installation Kit and Media to make a complete set. Installation Kit on pages 34-35, Media/Logs on pages 36-37.

FIRE PIT RINGS *(Requires Pan - Sold Separately)*

Item No	Description	Retail
SS-FR-12	12" Double-Ring Stainless Steel Burner with a 1/2" Inlet - 92,000 BTU	\$129
SS-FR-18	18" Double-Ring Stainless Steel Burner with a 1/2" Inlet - 147,000 BTU	\$139
SS-FR-24	24" Double-Ring Stainless Steel Burner with a 1/2" Inlet - 297,000 BTU	\$195
SS-FR-30	30" Triple-Ring Stainless Steel Burner with a 3/4" Inlet - 443,000 BTU	\$241
SS-FR-36	36" Triple-Ring Stainless Steel Burner with a 3/4" Inlet (Requires custom pan - 445,000 BTU)	\$289
SS-FR-48*	48" Triple-Ring Stainless Steel Burner with a 3/4" Inlet (Requires custom pan - 593,000 BTU)	\$496

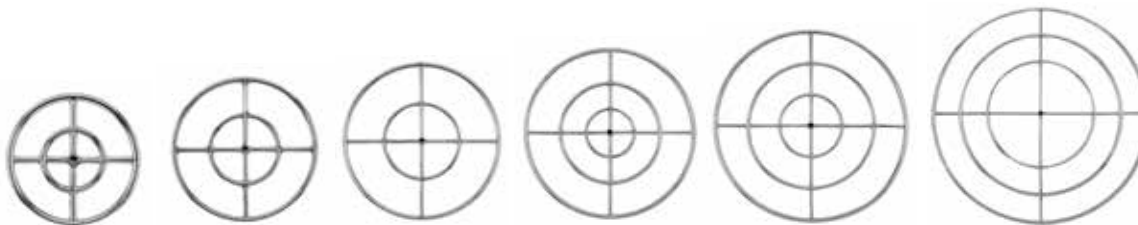

SS-FR-12

SS-FR-18

SS-FR-24

SS-FR-30

SS-FR-36

SS-FR-48

SQUARE FLAT PANS *(Requires Fire Pit Ring - Sold Separately)*

Item No	Description	Retail
SS-SQFP-18**	18" Square Stainless Steel Flat Pan (1/2" Nipple) (12" Ring)	\$220
SS-SQFP-30**	30" Square Stainless Steel Flat Pan (1/2" Nipple) (24" Ring)	\$440
SS-SQFP-36**	36" Square Stainless Steel Flat Pan (1/2" Nipple) (30" Ring)	\$584



Square Flat Pan shown w/ Ring Burner (Ring Burner Sold Separately)

*Special Order

**While Supplies Last

BUILD YOUR OWN FIRE PIT KIT



Select a Fire Pit Pan with Burner, Installation Kit and Media to make a complete set.
Media on pages 36-37.

DROP-IN PAN WITH BURNER, RECTANGLE

Item No	Description	Retail
SS-AFPP-24	24" x 8" Rectangle Stainless Steel Drop-In Fire Pit Pan, 122,825 BTU	\$289
SS-AFPP-30	30" x 10" Rectangle Stainless Steel Drop-In Fire Pit Pan, 126,200 BTU	\$360
SS-AFPP-36	36" x 12" Rectangle Stainless Steel Drop-In Fire Pit Pan, 170,500 BTU	\$479
SS-AFPP-48	48" x 14" Rectangle Stainless Steel Drop-In Fire Pit Pan, 218,300 BTU	\$659



Rectangle Drop-In Pan

DROP-IN PAN WITH BURNER, LINEAR

Item No	Description	Retail
SS-LCB-30*	30" x 6" Linear Stainless Steel Linear Drop-In Pan, 120,000 BTU	\$315
SS-LCB-36*	36" x 6" Linear Stainless Steel Linear Drop-In Pan, 130,000 BTU	\$360
SS-LCB-48	48" x 6" Linear Stainless Steel Linear Drop-In Pan, 130,000 BTU	\$479
SS-LCB-60	60" x 6" Linear Stainless Steel Linear Drop-In Pan, 130,000 BTU	\$659
SS-LCB-72	72" x 6" Linear Stainless Steel Linear Drop-In Pan, 130,000 BTU	\$720



Linear Drop-In Pan

INSTALLATION KIT & PARTS

Item No	Description	Retail
AFG-FPIK-N	Hoses, Fittings and Key Valve for Natural Gas	\$230
AFG-FPIK-P	Propane Regulator, Hoses, Air Mixer, Fittings and Key Valve	\$260
AFG-AIRMIXER	Propane Air Mixer	\$36
AFG-PBIKIT	Push-Button Spark Ignition Kit with Spark Probe (Battery Operated)	\$75



AFG-FPIK-N



AFG-FPIK-P



AFG-AIRMIXER



AFG-PBIKIT

MEDIA CALCULATOR & GAS PIPE SIZE CHART

FIREGLASS MEDIA CALCULATOR

Calculations are for Fire Pits with 3" Media Depth. Measure INSIDE Diameter of Fire Pit.

Square/Rectangular

Length x Width x 0.16 = Total Fireglass Weight

	12"	18"	24"	30"	36"	42"	48"	54"	60"	66"	70"
12"	23	34	45	57	68	79	90	101	113	124	131
18"	34	51	68	85	101	118	135	152	169	186	197
24"	45	68	90	113	135	158	180	202	225	247	262
30"	57	85	113	141	169	197	225	253	281	309	328
36"	68	101	135	169	202	236	270	303	337	371	393
42"	79	118	158	197	236	275	315	354	393	432	459
48"	90	135	180	225	270	315	360	404	449	494	524
54"	101	152	202	253	303	354	404	455	505	556	590
60"	113	169	225	281	337	393	449	505	562	618	655
66"	124	186	247	309	371	432	494	556	618	679	720
72"	135	202	270	337	404	472	539	606	674	741	786

Note: For rectangular fireplaces, use the same front width as back width

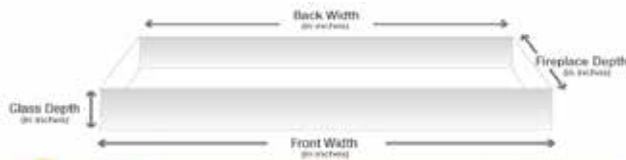

Round

Radius x Radius x 3.14 x 0.16 = Total Fireglass Weight

(Radius = Diameter x .5)

Diameter	Fireglass/Lbs.
12"	18
14"	24
16"	33
18"	41
20"	50
22"	60
24"	72
26"	84
28"	98
30"	113

Diameter	Fireglass/Lbs.
32"	128
34"	144
36"	162
38"	180
40"	200
42"	221
44"	242
46"	264
48"	288
50"	312



LAVA STONE CALCULATOR

Lava Stone = Total Fireglass Weight

LAVA ROCK CALCULATOR

Fireglass Weight / 2 = Total Lava Rock Weight

GAS PIPE SIZE CHART

Natural Gas Pipe Sizing Chart

Length of Pipe in Feet	Size of Pipe in Inches								
	½"	¾"	1"	1 ¼"	1 ½"	2"	2 ½"	3"	4"
10	108	230	387	793	1237	2259	3640	6434	
20	75	160	280	569	877	1610	2613	5236	9521
30	61	129	224	471	719	1335	2165	4107	7859
40	52	110	196	401	635	1143	1867	3258	6795
50	46	98	177	364	560	1041	1680	2936	6142
60	42	89	159	336	513	957	1559	2684	5647
70	38	82	149	317	476	896	1447	2492	5250
80	36	76	140	299	443	840	1353	2315	4900
90	33	71	133	275	420	793	1288	2203	4667
100	32	68	126	266	411	775	1246	2128	4518
125	28	60	117	243	369	700	1143	1904	4065
150	25	54	105	215	327	625	1008	1689	3645

Natural Gas flow is given in thousands of BTU/hour. One cubic foot of NG gas = 1000 BTU's.
NG Example: A burner that requires 224,000 BTU would need a 1" pipe for a 30' long run.

Liquid Propane Pipe Sizing Chart

Length of Pipe in Feet	Size of Pipe in Inches								
	½"	¾"	1"	1 ¼"	1 ½"	2"	2 ½"	3"	4"
10	275	567	1071	2205	3307	6221	10140	17990	35710
20	189	393	732	1496	2299	4331	7046	12510	25520
30	152	315	590	1212	1858	3465	5695	10110	20620
40	129	267	504	1039	1559	2992	4778	8481	17300
50	114	237	448	913	1417	2646	4343	7708	15730
60	103	217	409	834	1275	2394	3908	6936	14150
80	89	185	346	724	1086	2047	3329	5908	12050
100	78	162	307	630	976	1811	2991	5309	10830
125	69	146	275	567	866	1606	2654	4711	9613
150	63	132	252	511	787	1496	2412	4281	8736

Liquid Propane flow is given in thousands of BTU/hour. One cubic foot of LP gas = 2516 BTU's.
LP Example: A burner that requires 252,000 BTU would need a 1" pipe for a 150' long run.

Note for NG & LP: Pipe length must include additional length for all fittings.
Add approximately 5 feet of pipe per fitting.